

Operation Manual

PLM™ Series Powered Loudspeaker Management™ systems



1. Important Safety Instructions

Before using the device, be sure to carefully read the Safety Instructions. Keep this document with the device at all times.

1.1 Important Safety Instructions

1. Read these instructions.
2. Keep these instructions.
3. Heed all warnings.
4. Follow all instructions.
5. Do not use this apparatus near water.
6. Clean only with a dry cloth.
7. Do not block any ventilation openings. Install in accordance with the manufacturer's instructions.
8. Do not install near any heat sources such as radiators, heat registers, stoves, or other apparatus (including amplifiers) that produce heat.
9. Do not defeat the safety purpose of the polarized or grounding-type plug. A polarized plug has two blades with one wider than the other. A grounding-type plug has two blades and a third grounding prong. The wide blade or the third prong is provided for your safety. If the provided plug does not fit into your outlet, consult an electrician for replacement of the obsolete outlet.
10. Protect the power cord from being walked on or pinched, particularly at plugs, convenience receptacles, and the point where they exit from the apparatus.
11. Only use attachments/accessories specified by the manufacturer.
12. Use only with a cart, stand, tripod, bracket, or table specified by the manufacturer, or sold with the apparatus. When a cart is used, use caution when moving the cart/apparatus combination to avoid injury from tip-over.
13. Unplug this apparatus during lightning storms or when unused for long periods of time.
14. Refer all servicing to qualified service personnel. Servicing is required when the apparatus has been damaged in any way, such as power-supply cord or plug is damaged, liquid has been spilled or objects have fallen into the apparatus, the apparatus has been exposed to rain or moisture, does not operate normally, or has been dropped.
15. Use the mains plug to disconnect the apparatus from the mains.
16. **WARNING:** To reduce the risk of fire or electric shock, do not expose this apparatus to rain or moisture.
17. Do not expose this equipment to dripping or splashing and ensure that no objects filled with liquids, such as vases, are placed on the equipment.
18. The mains plug of the power supply cord shall remain readily operable.
19. Do not connect the unit's output to any other voltage source, such as battery, mains source, or power supply, regardless of whether the unit is turned on or off.
20. Do not remove the top (or bottom) cover. Removal of the cover will expose hazardous voltages. There are no user serviceable parts inside and removal may void the warranty.
21. An experienced user shall always supervise this professional audio equipment, especially if inexperienced adults or minors are using the equipment.
22. The US National Differences clause 16.3 requires that network cables must be flame rated VW-1.



To prevent electric shock do not remove top or bottom covers. No user serviceable parts inside, refer servicing to qualified service personnel.



À prévenir le choc électrique n'enlevez pas les couvercles. Il n'y a pas des parties serviceable à l'intérieur, tous reparations doit être faire par personnel qualifié seulement.



To completely disconnect this equipment from the AC mains, disconnect the power supply cord plug from the AC receptacle. The mains plug of the power supply cord shall remain readily operable.



Pour démonter complètement l'équipement de l'alimentation générale, démonter le câble d'alimentation de son réceptacle. La prise d'alimentation restera aisément fonctionnelle.



1.2 Standards



This equipment conforms to the requirements of the EMC Directive 2004/108/EC and the requirements of the Low Voltage Directive 2006/95/EC.

Standards applied: EMC Emission EN55103-1, E3
EMC Immunity EN55103-2, E3, with S/N below 1% at normal operation level.
Electrical Safety EN60065, Class I



This equipment is tested and listed according to the U.S. safety standard ANSI/UL 60065 and Canadian safety standard CSA C22.2 NO. 60065. Intertek made the tests and they are a Nationally Recognized Testing Laboratory (NRTL).

1.3 Explanation of Graphical Symbols



The lightning bolt triangle is used to alert the user to the presence of un-insulated "dangerous voltages" within the unit's chassis that may be of sufficient magnitude to constitute a risk of electric shock to humans.



The exclamation point triangle is used to alert the user to presence of important operating and service instructions in the literature accompanying the product.

1.4 WARNING



To reduce risk of fire or electric shock, do not expose this apparatus to rain or moisture.
Pour réduire les risques de blessure ou le choc électrique, n'exposez pas l'appareil à la pluie ou à l'humidité.

Do not expose this system/apparatus to dripping or splashing and ensure that no objects filled with liquids, such as vases, are placed on the apparatus.

L'appareil ne doit pas être exposé à des égouttements d'eau ou des éclaboussures et de plus qu'aucun objet rempli de liquide tel que des vases ne doit pas être placé sur l'appareil.

This apparatus must be connected to a mains socket outlet with a protective earthing connection.
Cet appareil doit être raccordé à une prise de courant qui est branchée à la terre.

The mains plug is used as a disconnect device and shall remain readily operable.

Lorsque la prise du réseau d'alimentation est utilisée comme dispositif de déconnexion, ce dispositif doit demeurer aisément accessible.

1.5 CAUTION



To reduce the risk of fire or electric shock, do not remove screws. No user-serviceable parts inside.
Refer servicing to qualified service personnel.

Pour réduire le risque d'incendie ou de choc électrique, ne pas retirer les vis. Aucune pièce réparable par l'utilisateur. Confier l'entretien à personnel qualifié.

1.6 FCC Compliance Notice (Radio Interference)

A sample of this product has been tested and complies with the limits for the European Electro Magnetic Compatibility (EMC) directive. This equipment has also been tested and found to comply with the limits for a Class B digital device, pursuant to Part 15 of the FCC Rules. These limits are designed to provide reasonable protection against harmful interference from electrical equipment. This product uses radio frequency energy and if not used or installed in accordance with these operating instructions, may cause interference to other equipment, such as radio receivers.

However, there is no guarantee that interference will not occur in a particular installation. If this equipment does cause harmful interference to radio or television reception, which can be determined by turning the equipment on and off, the user is encouraged to try to correct the interference by one or more of the following measures:

- ▶ Reorient or relocate the antenna.
- ▶ Increase the separation between the equipment and receiver.
- ▶ Connect the equipment to an outlet on a circuit different from that to which the receiver is connected.

- ▶ Check if the affected unit complies with the EMC limits for immunity, (CE-labeled). If not, address the problem with the manufacturer or supplier. All electrical products sold in the EC must be approved for immunity against electromagnetic fields, high voltage flashes, and radio interference.
- ▶ Consult the dealer or an experienced radio/TV technician for help.

1.7 User Responsibility

1.7.1 Mains Connection Grounding

 Your apparatus must be connected to a grounded socket outlet.

1.7.2 Speaker Output Hazard on Amplifiers

 Amplifiers are capable of producing hazardous output voltages. To avoid electrical shock, do not touch any exposed speaker wiring while the amplifier is operating. The external wiring connected to the speaker terminals shall be installed by a qualified person, or ready-made leads or cords of appropriate capacity shall be used.

 As the power output channels on amplifiers produce high voltage, do not connect or disconnect speaker cables when the mains power is on.

1.7.3 Speaker Damage

Amplifier apparatus is very powerful and can be potentially dangerous to both loudspeakers and humans alike. Many loudspeakers can be easily damaged or destroyed by overpowering them. Always check the speaker's continuous and peak power capabilities. Although the amplifiers attenuators can be used to reduce the overall gain, an increase of the input signal can result in full output power, which may cause damage to connected speakers.

1.7.4 Maintenance

For safe and reliable operation, the dust filters on both sides of the front panel, behind the grilles, should be removed and cleaned regularly to ensure maximum airflow through the device.

 If the dust filters are not maintained there will be safety risks; for example, high internal temperatures could ignite the dust and start a fire. There is also a risk that the unit will malfunction since it is dependent on constant airflow from front to rear. If the dust filters are not clean and the unit malfunctions, any resulting problems will not be covered by the warranty.

Table of Contents

1. Important Safety Instructions	i
1.1 Important Safety Instructions	i
1.2 Standards	i
1.3 Explanation of Graphical Symbols	i
1.4 WARNING	ii
1.5 CAUTION	ii
1.6 FCC Compliance Notice (Radio Interference).....	ii
1.7 User Responsibility	iii
2. Welcome	1
2.1 Introduction	1
2.2 Main Features	1
2.3 Additional Documentation.....	3
3. Installation	4
3.1 Unpacking	4
3.2 Mounting.....	4
3.3 Cooling	6
3.4 Operating Voltage	6
3.5 Grounding.....	7
4. Product Overview	9
4.1 Front Panel Overview.....	9
4.2 Back Panel Overview	12
5. Operation and Performance	16
5.1 Operation Precautions.....	16
5.2 Power Output Performance	16
5.3 Amplifier and Load Protection Systems.....	18
5.4 Power Supply	25
6. Signal Flow and Lake® Processing	26
6.1 Signal Flow	26
6.2 Lake Processing and Control.....	28
6.3 Modules and Frames	28
6.4 Loudspeaker Crossover Configuration Overview.....	29
6.5 Files and Presets.....	30
7. Front Panel Interface	31
7.1 Overview.....	31
7.2 Front Panel Key Lock.....	32
7.3 Power Button	32
7.4 Mute Enable Button	33

7.5	Meter Button	33
7.6	Menu Button	33
7.7	Exit Button	33
7.8	Dynamic Buttons, Controls and LEDs.....	34
7.9	Warning and Fault Indications	39
7.10	Meter Mode	42
7.11	Menu Mode	46
8.	Back Panel Interface	63
8.1	Speaker Outputs	63
8.2	Analog Inputs and Outputs	68
8.3	AES3 Digital I/O	70
8.4	RJ45 etherCON Network Connections.....	71
8.5	Power Inlet.....	72
9.	Appendix.....	73
9.1	Faults and Warnings Overview	73
9.2	Maintenance	77
9.3	Factory Default Settings.....	77
9.4	Current Draw and Thermal Dissipation Specifications	78
9.5	Glossary of Terms, Acronyms and Abbreviations	82
10.	Application Guide.....	85
10.1	Rack I/O Panels.....	85
10.2	Power Distribution.....	85
10.3	Gain Structure	86
10.4	Gain / Level Optimization	88
10.5	Speaker Configurations	91
10.6	Digital Audio Connections	92
10.7	Digital Clock Configuration.....	95
11.	Technical Specifications	97
12.	Warranty and Support	98
12.1	General	98
12.2	International Warranties	98
12.3	Technical Assistance and Service	98
12.4	Trademarks.....	99

2. Welcome

2.1 Introduction

Thank you for choosing the Lab.gruppen PLM Series of Powered Loudspeaker Management systems for your sound reinforcement needs. We are confident that you will be pleased with the performance, unique features, configuration flexibility, reliability, and long-term durability offered by this product.

For fast installation and use of this product, your welcome package includes a printed copy of the PLM Series Quick Start & Field Reference Guide which contains the information required to safely install the product and place it in service. Control and editing features are accessible via the front panel interface or via the included Lake Controller software.

It is recommended that the Quick Start & Field Reference Guide and all product documentation on the included CD-ROM is reviewed to ensure familiarity with the various configuration and control options.

Thank you again for placing your confidence in Lab.gruppen products.

2.2 Main Features

The PLM Series incorporates a number of sophisticated technologies to ensure the best possible performance and many years of reliable operation. The following section summarizes the benefits of each feature; additional information is available in the reference manuals.

2.2.1 Amplifier Platform

The PLM Series power output section has expanded upon Lab.gruppen's robust, road-proven FP+ Series amplifiers. Features in common with the FP+ Series include extraordinary power density, patented Class TD[®] output stages, Regulated Switch Mode Power Supply (R.SMPS[™]), the high-efficiency Intercooler[®] copper-finned cooling system, and a full suite of protection features. Signal inputs are analog, AES digital, and Dante digital audio network; loop-through outputs or redundant pairs are provided for each input type.

Please refer to section 5.3 for further information.

2.2.2 Amplifier DSP (Digital Signal Processor)

Various features of PLM Series devices are controlled by the on-board DSP, some of which are summarized in this section.

2.2.2.1 Input Gain (Sensitivity)

Input gain (sensitivity) is set in the digital domain for PLM Series devices, and may be controlled via the Lake Controller software or front-panel interface.

2.2.2.2 ISVPL™

The Inter-Sample Voltage Peak Limiter (ISVPL) tailors each power output to the characteristics of the connected load. Please refer to section 5.3.1 for further information.

2.2.2.3 Load Verification & Performance Monitoring

A comprehensive set of proprietary DSP-based tools are provided for load verification and real-time performance monitoring. These functions utilize LoadLibrary, a comprehensive database for each loudspeaker component of the connected load (usually one or more band-limited drivers in a multi-way system).

Using this data and a brief test signal, LoadSmart compares actual response to predicted response, identifying any malfunctioning components or connection errors. During the performance, SpeakerSafe™ monitors real-time load status, including temperatures of the PLM amplifier stages as well as magnets and voice coils of connected loudspeakers. This allows operators to avoid power compression and identify potential problems.

Please refer to the Lake Controller Operation Manual for detailed information on PLM Series load verification and real-time performance monitoring functionality.

2.2.3 Lake Processing and Controller

PLM Series devices integrate seamlessly into the Lake Processing environment. Two processing modules offer precise settings for gain, delay, crossover settings, equalization and limiting. Lake processing features incorporated in each module include Raised Cosine Equalization™, linear phase crossovers, and LimiterMax™ loudspeaker protection. The Super Module feature allows hardware processing modules in two or more separate devices to function as a single module in the Lake Controller software. Please refer to the Lake Controller Operation Manual for further information.

2.2.4 Lake Analyzer Bridge

Lake Controller software provides integration with third-party real-time analyzers, providing simultaneous measurement display and EQ adjustment via the Lake Controller.

The third-party measurement tools that can be integrated via the Analyzer Bridge include:

- ▶ Smaart Live Version 5.4
- ▶ Live-Capture Light / Live-Capture Pro

Smaart, distributed and supported by Rational Acoustics, provides real-time sound system measurement, optimization and control. Smaart combines several powerful audio frequency measurement and analysis tools.

Live-Capture, created by WaveCapture, offers easy-to-use software and measurement tools for sound engineers, installers, consultants and designers. The Lake Analyzer Bridge in conjunction with Live-Capture Light provides a completely free spectrum analyzer via your Lake Controller software interface.

2.2.5 Dante™ Audio Network

PLM Series devices include Dante digital audio networking as standard. Utilizing the latest advances in Ethernet technology, Dante offers simplified system configuration and extremely low latency while delivering very high quality uncompressed digital audio across the Lake network. The Zen™ automatic configuration feature enables plug-and-play setup without third-party DHCP or DNS servers. Dante is compatible with high-bandwidth networks, allowing large numbers of audio channels to be distributed alongside control and analyzer data.

2.3 Additional Documentation

This document, the PLM Series Operation Manual, serves as the primary reference source for detailed information on the installation and operation of PLM Series Powered Loudspeaker Management systems. It also provides detailed information on set-up and configuration using the front-panel interface.

If you intend to use the device as part of a networked system, or access features via the Lake Controller, please refer to the various supporting documents which can be located via these methods:

- ▶ Start > Programs > Lake Controller > Documentation (after installing Lake Controller software)
- ▶ On the Installer CD-ROM or the downloaded software installer
- ▶ Online at: <http://labgruppen.com/index.php/products/documentation/>

3. Installation

3.1 Unpacking

Carefully open the shipping carton and check for any damage to the device or the supplied accessories. Every Lab.gruppen product is tested and inspected before leaving the factory and should arrive in perfect condition. If any damage is discovered, please notify the shipping company immediately. Only the consignee may initiate a claim with the carrier or their insurers for damage incurred during shipping. Save the carton and packing materials for the carrier's inspection.

In addition to the PLM, the shipping carton include the following items:

- ▶ PLM Series Quick Start & Field Reference Guide
- ▶ AC mains lead (power cable) with Neutrik® powerCON® connector
- ▶ Rear brackets for additional rack support (pair) along with associated mounting hardware
- ▶ Software Installer and Documentation CD-ROM

Please keep the original carton and associated packaging to facilitate shipping of the device should the need arise.

3.2 Mounting

Airflow for cooling the PLM is from front panel (intake) to rear panel (exit). Please ensure that no object, such as rack doors or lids are placed at the front or rear of the rack to ensure that airflow is maximized. This device has no top or bottom vents and therefore may be stacked directly on top of each other.

Sufficient space should be available at the front of the rack to accommodate the handles, and at the rear to accommodate connectors and cables; allowance must be made for cable or loom bends within a rack.

3.2.1 Rear Mounting

Two rear support brackets along with associated mounting hardware are included with the PLM, as shown in Figure 3-1; it is recommended that these are used wherever possible. Fit the brackets to the vertical rails at the rear of the rack. Figure 3-2 and Figure 3-3 show the fitting options for fixed and removable installation.

The support brackets are reversible and may be fitted to point either to the front or rear of the rack; the orientation used depends on the rack depth and position of the rear rack rails.

Two mounting methods are possible; note that the method shown in Figure 3-2 additionally provides extra security against unauthorized removal. For situations where rapid removal and replacement is required, the method shown in Figure 3-3 should be used.

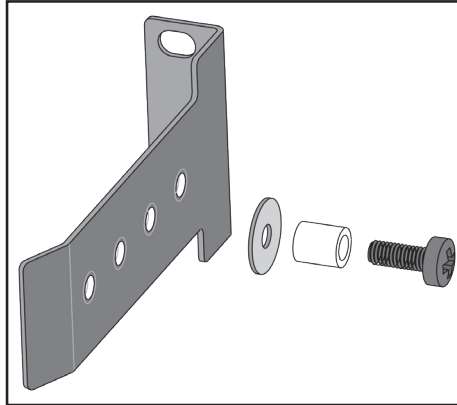

Figure 3-1: Rear Support Bracket and Mounting Hardware

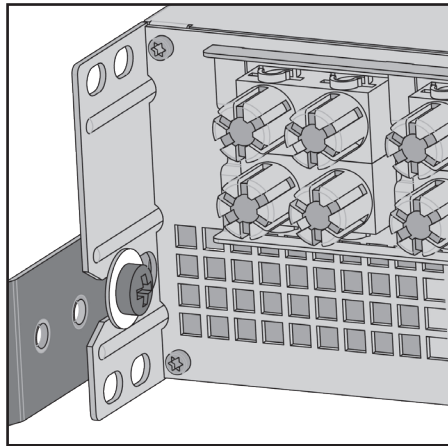

Figure 3-2: Use the Washer for Fixed Installations

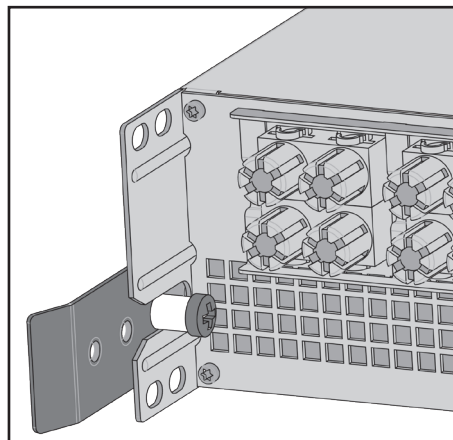



Figure 3-3: Use Tube for Slide-On Installation

3.3 Cooling

3.3.1 Overview

The PLM Series devices use a forced-air cooling system with airflow from front to rear, allowing high continuous power levels without thermal problems. Front-to-rear airflow is preferable as air at the front of a rack is cooler than that at the rear in nearly all situations; never attempt to reverse the airflow. The operation of the PLM's cooling system is dependent on front-to-rear airflow; it will not function effectively with external airflow in the opposite direction.

 Make sure an adequate air supply is provided in front of the PLM, and that the rear of the PLM has sufficient space to allow air to escape. If the PLM is rack-mounted, never operate the unit with any front or rear rack doors or covers in position. It is recommended to keep the ambient temperature around the PLM as cool as possible. An increased temperature can have a significant negative impact on the expected lifetime on the components inside the PLM.



Fit solid blanks (not ventilation blanks) to unused rack spaces to ensure effective air circulation. Leaving gaps in between items of equipment degrades the effectiveness of forced-air cooling.

 If installing one or more PLM Series devices in a rack with other fan-cooled equipment, be sure that all the other equipment also uses front-to-rear airflow for cooling. If this precaution is not observed, there is a risk of overheating, as units with the reverse airflow will be drawing in air which has already been heated by the PLMs.

3.3.2 Temperature Sensing and Protection

The PLM is equipped with a sophisticated temperature sensing system which protects it from any overheating which may occur as a result of inadequate ventilation.



Always ensure the dust filters behind the detachable front panel are clean to ensure maximum possible airflow.

3.4 Operating Voltage

 The label adjacent to the mains (AC) input connector indicates the AC mains voltage for which the device is wired and approved. The PLM 10000Q and PLM 14000 devices are available in separate 115 V and 230 V versions; the PLM 20000Q is only available with a universal power supply operating from 80 to 265 V. Only connect the mains cable (AC cord) to an AC source of the voltage shown on the label.

The PLM uses primary switching, which means the mains power is rectified on the primary side of the transformer. This makes the power supply insensitive to mains frequency variation, and it will operate normally on line frequencies from 45 to 75 Hz.

If the mains plug (AC plug) fitted to the mains cable (AC cord) is not appropriate for your country, it can be removed and a locally-sourced one fitted instead, observing the color coding in the table below:



powerCON Pin	230 V Version	115 V Version
L	Brown	Black
N	Blue	White
	Green/Yellow	Green

Table 3-1: AC Plug Configuration

 If you are not 100% confident of your competence to replace the mains plug (AC plug), the task should be carried out by qualified personnel.

Once a suitable AC power supply is connected, the device can be turned on using the front panel power button. When turned on, a diagnostic routine is performed and the power button LED changes from red (Standby) to green (Active).



In-rush current is controlled and limited during the soft-start sequence. This enables multiple PLMs on the same AC mains circuit to be turned on simultaneously.

3.5 Grounding

Analog inputs feature Iso-Float™ ground isolation, a technology which combines the benefits of transformer-coupled isolation with the advantages of clean, direct-coupled inputs.

The audio converters are galvanically isolated, and not connected to the main ground. High-speed transformers and opto-isolators create a barrier between the device and the outside electrical environment.



The Iso-Float feature is activated by default, but may be disabled via the Lake Controller software, or via the front panel menu.

Use correctly-shielded balanced audio input connections to minimise hum and interference. Please refer to section 8.2.4 for further information.

 NEVER disconnect the earth (ground) pin on the mains cable (AC power cord).

4. Product Overview

This chapter provides an overview of key features and functionality. For further information please see chapters 5 to 10 of this Operation Manual.

4.1 Front Panel Overview



Figure 4-1: PLM Front Panel Overview

The front panel controls are clustered around a daylight readable LCD (3), allowing adjustment and monitoring of the majority parameters and meters. The two clusters of controls on either side of the LCD include five dedicated function buttons (4, 5, 6, 7, 12), eight dynamic function buttons with embedded LEDs (8, 9) and a rotary data encoder (11).

1 Handles

Two sturdy metal handles are fitted to the front panel. The handles should be used when carrying the device, and when fitting it in or removing it from a rack. Ensure that any door or removable rack front cover has sufficient depth to clear the handles.

2 Dust Filters

Two dust filters are fitted behind metal covers. To remove the covers, loosen the thumbscrews located behind the handles. Once detached, the dust filter elements can be removed for cleaning; please refer to section 9.2 for further information.



NEVER operate this device without the dust filters in place.

③ Display

The display illuminates when the device is on. The LCD, function buttons, and the rotary encoder provide real-time control and monitoring of most parameters. The LEDs embedded in the function buttons indicate available menu options, provide confirmation of Controller communication, and indicate various faults and warnings.

The brightness and contrast of the display and front panel LEDs can be adjusted via the front panel menu.

Please refer to chapter 7 for further details.

④ Standby

PLM Series devices are powered on and to standby using the top-left button, or via the Lake Controller.

⑤ Mute Enable

Select MUTE ENABLE to allow the dynamic function buttons to operate as mute controls for the Module inputs and power output channels. The MUTE ENABLE button flashes when the mode is selected; a subsequent press deselects this mode. If left activated, MUTE ENABLE mode will automatically disable two minutes after the last mute action.

⑥ Meter

The METER button scrolls through four alternative meter views: Home View, Module View, Temperature View and Input View. Pressing METER from Menu Mode returns the screen to Meter Mode with Home View displayed. Please refer to section 7.5 for further details.

⑦ Menu

After pressing the MENU button, the LCD will display the top level menu. In Menu Mode the function buttons enable access to various information and functions. Please refer to section 7.6 for further details.

⑧ Dynamic Function Buttons with LEDs (Left of LCD)

The function of these buttons change according to the currently selected view or menu.

- ▶ In Menu Mode they are used for menu navigation and for parameter selection
- ▶ In Meter Mode they provide Module input mute/unmute functionality in conjunction MUTE ENABLE

The LED in the top button provides Frame fault and warning indications. The middle two buttons provide Module input mute functionality, mute indication and faults and warning indications relating to the PLM inputs. The bottom button is used only in Menu Mode or to lock the front panel buttons.

Please refer to chapter 7 for further details.

9 Dynamic Function Buttons with LEDs (Right of LCD)

The function of these buttons change according to the currently selected view or menu.

- ▶ In Menu Mode they are used for menu navigation and for parameter selection
- ▶ In Meter Mode they provide PLM output mute/unmute functionality in conjunction MUTE ENABLE

All LEDs provides mute, clip, fault and warning indications for the PLM power outputs channels.

Please refer to chapter 7 for further details.

10 Communication LED

The high-intensity white LED illuminates white to indicate that the Module/Frame is selected in the Lake Controller; it flashes white to indicate communication with the Lake Controller.

The brightness of the LCD and communications LED can be adjusted in the Frame page of the Main Menu on the front panel.

11 Rotary Encoder

The rotary encoder is used to modify various parameters (e.g. input level) via the menu. When a menu item is selected that permits adjustment of parameter values, the ring around the rotary encoder illuminates. In Home View the encoder can be used to scroll through the Meter Views.

12 Exit

The EXIT button is used primarily while navigating the menu system in Menu Mode; pressing EXIT will return the menu up one level. In Meter Mode, pressing EXIT returns the metering display to the default Home View.

4.2 Back Panel Overview

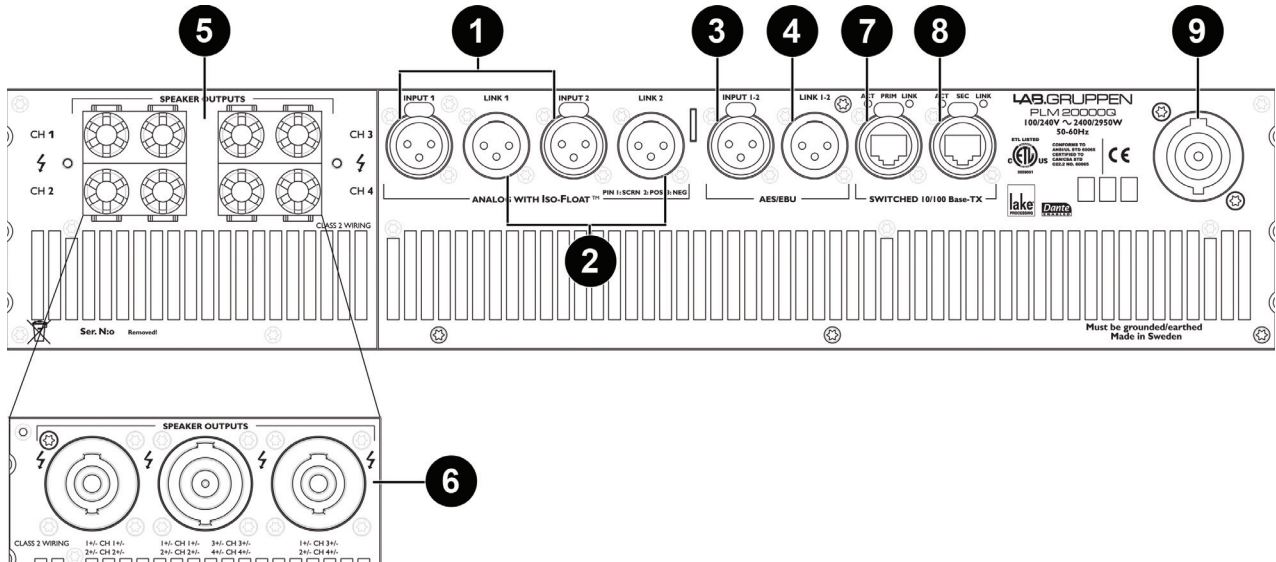

Figure 4-2: Back Panel Layout Options for a 4-channel PLM

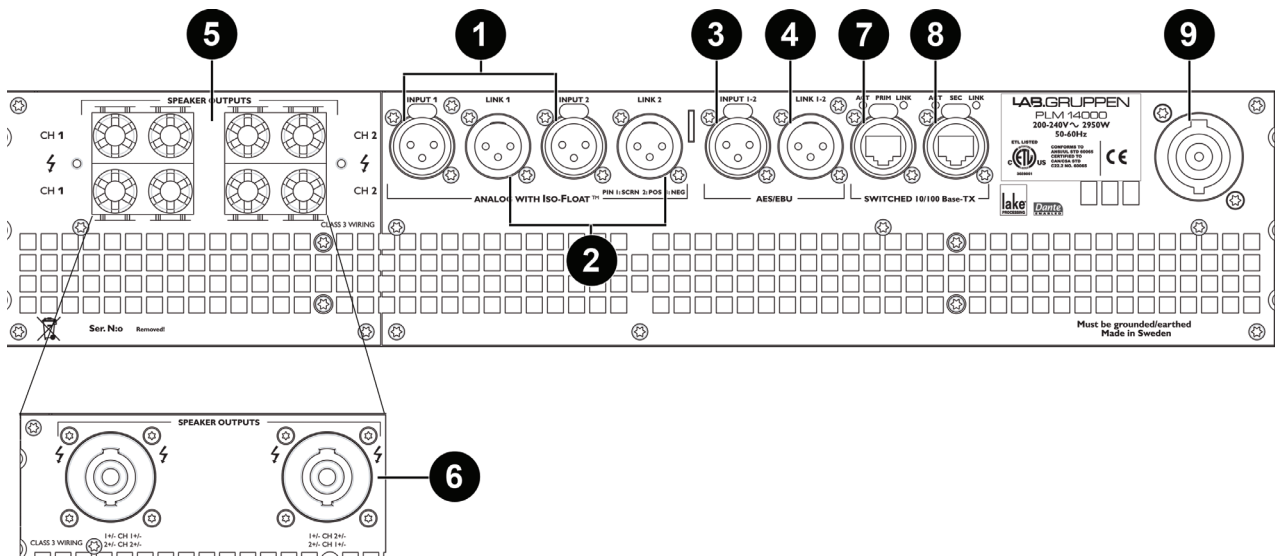

Figure 4-3: Back Panel Layout Options for a 2-channel PLM

4.2.1 Input and Link Connectors

① Analog Inputs

Analog inputs are available on two standard XLR3F latching connectors. The inputs are electronically balanced and feature Lake Iso-Float circuitry. The impedance is 20 kohms, and the inputs can accept a maximum input level of +26 dBu.

② Analog Links

Two latching XLR3M connectors are fitted adjacent to the analog input connectors. These are paralleled to the input connectors to provide an unprocessed analog loop-through to feed additional PLM Series units, or other equipment.

③ AES3 Inputs

A latching XLR3F connector is provided which accepts an AES3 digital audio signal. Input impedance is 110 ohms, please ensure that 110 ohm digital audio cables are used; standard XLR microphone cables are rarely suitable for reliable digital audio transmission.



AES3 is a stereo digital format, and therefore both PLM inputs are fed via a single connector. Selection of the analog or digital inputs is made via the front panel display or control software.

④ AES3 Link

A latching XLR3M connector is fitted adjacent to the AES3 input connector. This is paralleled to the input connector to provide an unprocessed AES3 loop-thru to feed further PLMs, or other equipment. An AES3 110 ohm termination load is enabled by default when the PLM is the last unit connected within an AES3 daisy-chained system. The termination may be disabled, if desired, via the front panel menu and within the Lake Controller software.

4.2.2 Output Connectors

The PLM is available with a choice of connectors for power outputs: binding posts or Neutrik speakON®. Both connection methods allow for Bridge Mode operation, which is activated from the Lake Controller software. Please refer to the Lake Controller Operation Manual and section 8.1.1 of this Operation Manual for further information on Bridge Mode.

⑤ Binding Posts

In this version, the power outputs for loudspeaker connection are available on four separate pairs of fully enclosed binding posts. Bridge Mode can be enabled via the Lake Controller software, please refer to the Lake Controller Operation Manual for further information.

Channel configuration for the binding posts is dependent on the PLM model, please refer to section 8.1.3 of this Operation Manual for standard and Bridge Mode wiring.

⑥ speakON Connectors

The speakON connector configuration differs on 2-channel and 4-channel PLM models.

On 4-channel models, the power outputs are simultaneously available on a single 8-pole speakON connector, and on two 4-pole speakON connectors. The two 4-pole connectors carry the outputs of channels 1 & 2 and 3 & 4 respectively.

On 2-channel PLM models the two power output channels are available simultaneously on two 4-pole speakON connectors. Both connectors carry both channels. The second connector offers the channels in reverse order.

Bridge Mode can be enabled via the Lake Controller software, please refer to the Lake Controller Operation Manual and to section 8.1.2 of this Operation Manual for further details on standard and Bridge Mode wiring for speakON connectors.

4.2.3 Ethernet and Power Connectors

⑦ Primary Network Connector

The primary Neutrik RJ45 etherCON® connection provides integration into an Ethernet control network which may include other Lake Processors and the Lake Controller software. Network connection permits full control of all functions along with real-time metering from a remote position. This device supports the Dante audio networking protocol, which allows transmission of multichannel, high-definition digital audio over the same Ethernet connection.

Use the primary connector when using a star network topology, consisting of individual Cat-5e connections between the devices and an Ethernet switch. Alternatively this connection can be used to daisy chain directly to another Lake Processor. The daisy chain topology should not be used with Dante.

For a technical reference of the Ethernet Port, please refer to section 8.4. Additional information is available in the Lake Network Configuration Guide.



The Ethernet ports operate at the Ethernet data rate of 100 Mbps, and allow straight or crossed network cables. Two LEDs above each port indicate valid network connection (LINK) and network activity (ACT).

8 Secondary Connector

The secondary network connector can be used to daisy-chain multiple PLM Series, LM 26 and legacy Lake devices. Alternatively, a Dante dual-network topology can be created by connecting all secondary network connectors to a separate Ethernet switch, ensuring full redundancy in the event of a network component failure.



Additional processor configuration is required for a dual redundant network setup. See the Lake Controller Operation Manual for further details.

For a technical reference of the Ethernet Port, please refer to section 8.4. Additional information is available in the Lake Network Configuration Guide.



When connecting multiple devices to an Ethernet network, care must be taken NOT to create a closed loop which causes network malfunction.

9 Mains Power Connector

The mains power AC input is via a Neutrik powerCON connector, rated at 32 A.

The power supply must be connected to AC mains using a power cable with a correctly wired plug for the country of operation.

5. Operation and Performance

This chapter provides comprehensive information on PLM Series connection, setup, operation and performance. The detailed information included here is essential to realizing the full functionality of the PLM Series devices.

5.1 Operation Precautions

Make sure that the Standby button on the PLM's front panel is either unlit (OFF), or red (STANDBY), before making any input or output connections.

 Ensure the AC voltage matches that printed on the label adjacent to the AC mains connector.

Ensure no input signal is present when powering on the PLM to reduce the risk of any inadvertent bursts of high level audio.

5.2 Power Output Performance

The PLM uses Lab.gruppen's patented Class TD technology in the output stages, which couples the efficiency of Class D topologies to the sonic purity of Class B designs.

The primary benefit is that Lab.gruppen's Class TD works perfectly under all load conditions. The output maintains its flat frequency response even into complex loads with very low nominal impedances. Reliability is very high, and there is no interference with nearby RF equipment. Superior efficiency allows greater power density while minimizing cooling requirements, yet sound quality matches that of the best Class B designs.

5.2.1 Symmetrical Power

The PLM models can deliver power as shown in Table 5-1 when all channels are driven equally.

Load Impedance (ohms)	2.0	2.7	4	8	16
PLM 10000Q Max. Output power (Watts)	2350	2700	2300	1300	660
PLM 14000 Max. Output power (Watts)	7000	6000	4300	2300	1150
PLM 20000Q Max. Output power (Watts)	4800	5000	4440	2300	1150

Table 5-1: Symmetrical Load Power Ratings

5.2.2 Asymmetrical Power

The PLM models can deliver power as shown in Table 5-2 when every other channel is driven 3 dB lower than the other. This can occur when the load on the individual power output channels within the amplifier contain different frequency ranges.

Load Impedance (ohms)	2.0	2.7	4	8	16
PLM 10000Q					
Max. Output power (Watts)	2350	2900	2400	1300	660
PLM 14000					
Max. Output power (Watts)	7500	6300	4400	2300	1150
PLM 20000Q					
Max. Output power (Watts)	5000	5550	4500	2300	1150

Table 5-2: Asymmetrical Load Power Ratings

5.2.3 Power Over Time

Power ratings given above are applicable for PLMs running at these levels for a period of 60 minutes. Due to thermal considerations in the power supply and elsewhere, it is possible to draw higher power levels for a shorter period of time. The graph below illustrates, for the example PLM 10000Q, how the rated power figures are derived and the higher short-term capability.

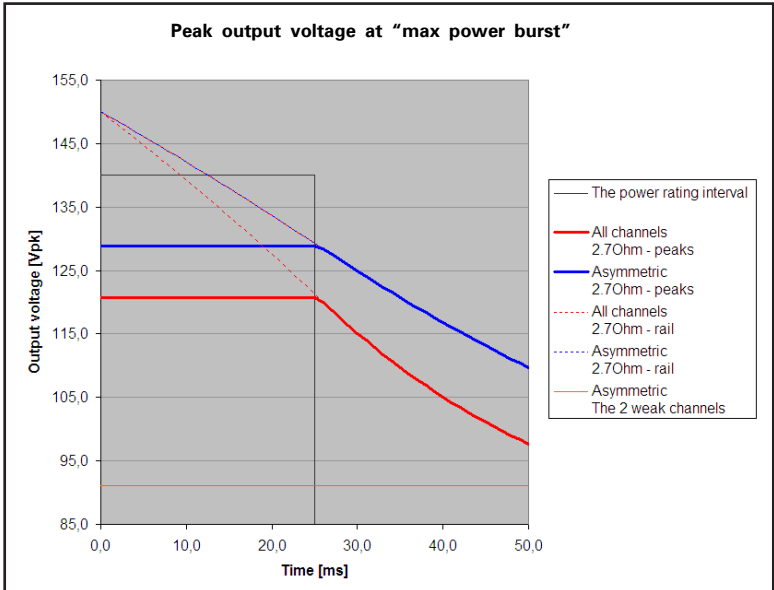

Figure 5-1: Power Rating Levels OverTime (PLM 10000Q)

Power ratings are based on a duty cycle of 25 ms full power every 400 ms. Between bursts, a lower signal level applies, such that the continuous average power is 1/8th of the rated power.

In reality, when some channels are delivering less than maximum rated power, energy reserves in the PSU are available to permit other channels to deliver more power. The graph shows the peak output voltage over time for a continuous sine wave is applied.

If all four channels are driven with the same signal into the same impedance (solid red line), then the rail voltage (dotted red line) will drop faster than when two channels are delivering maximum power (solid blue line) and two channels are delivering half-power (solid orange line). This is termed asymmetric loading; the rail voltage for this is indicated by the dotted blue line.

It can be seen that higher power output is available for 25 ms bursts with asymmetric loading.

5.3 Amplifier and Load Protection Systems

The PLM is equipped with a comprehensive set of protection circuits. If operating conditions become sufficiently extreme that any of these circuits become active, indication is provided by LEDs in one or more soft function buttons 5-8, together with adjacent warning text. In addition to this, notification is also presented within the Lake Controller software and within system log files.

5.3.1 Inter-Sample Voltage Peak Limiter (ISVPL)

The ISVPL is a high quality voltage limiter that can deliver seamless limitation to any desired level. Its ensures that the voltage at the output terminals never exceeds the defined threshold.

It operates on these principles:

- ▶ The signal is delayed slightly to allow the ISVPL to look-ahead and reduce the gain before voltage in excess of the threshold can appear at the output. This results in zero voltage overshoot at the output with a rounded limitation up to the threshold.
- ▶ The amplitude of the output signal between digital samples is predicted which permits the ISVPL to respond to analog peaks that may occur at the digital to analog converter.
- ▶ The release time of gain reduction is adaptive depending on the dynamics of the signal.

It is possible to select different ISVPL profiles for limiting optimization for a specific frequency band and personal preference. The profiles are divided into two categories, with one category optimized for low distortion and the other focusing on producing high sound pressure level (SPL). Within each category there are profiles optimized for the different frequency bands.

5.3.1.1 Low Distortion Profiles

- ▶ Universal – The universal profile is a soft limiter that can be used for all frequencies and is conservative in its action upon VCL and CPL.
- ▶ Sub/LF – The Sub/LF profile is tuned for frequency bands below 600Hz. It has longer attack and release times and is less conservative when it comes to acting upon VCL and CPL.

5.3.1.2 High SPL Profiles

High SPL profiles do not use the adaptive release time feature. High SPL profiles optimized for high frequencies use less of the look-ahead delay peak-rounding feature; this feature is used most in the Sub profile and least the HF profile.

- ▶ Sub - The Sub profile is optimized for frequencies between 20 - 200 Hz
- ▶ LF - The LF profile is optimized for frequencies between 20 - 1200 Hz
- ▶ MF - The MF profile is optimized for frequencies between 300 - 6000 Hz
- ▶ HF - The HF profile is optimized for frequencies above 1 kHz

Table 5-3 shows the theoretical maximum output power for a given load impedance and ISVPL setting.



An ISVPL-to-load calculator that will assist in generating the appropriate ISVPL setting for a desired power load is available at www.labgruppen.com/plm

MAX. SINEWAVE BURST POWER (Watts)					
Load Impedance (ohms)	2	2.67	4	8	16
ISVPL SETTING (V peak)					
194	9409	7048	4705	2352	1176
193	9312	6984	4656	2328	1164
181	8190	6143	4095	2048	1024
167	6972	5229	3486	1743	872
153	5852	4389	2926	1463	732
121	3660	2745	1830	915	458
101	2550	1913	1275	638	319
83	1722	1292	861	431	215
70	1225	919	613	306	153
56	784	588	392	196	98
47	552	414	276	138	69
38	361	271	181	90	45
17.8	79	59	40	20	10

Table 5-3: ISVPL-to-output examples



These ratings shown in Table 5-3 are limited by the CPL (Current Peak Limiter) functions, not by ISVPL settings, due to power output channel current capacity.

The ISVPL threshold may be set at any level between 17.8 V and 600 V via the PLM's menu system. For further details, please refer to section 7.11.2.5 of this manual, and also to the PLM Series chapter in the Lake Controller User Manual.

PLM devices that have a smaller peak output voltage can still set the ISVPL threshold up to 600 V. When a threshold is set above the maximum capability of a power output channel, the maximum ISVPL for that product will be automatically set. Therefore, the ISVPL threshold can be in at the Module for the speaker's maximum capability, and the Module file remains cross-compatible with all PLM Series devices.

5.3.2 Current Peak Limiter (CPL)

The output Current Peak Limiter (CPL) ensures that the power output section will not be damaged by forcing it to deliver current levels at the outputs that exceed the maximum current ratings of the output transistors. The CPL keeps the output transistors within their Safe Operating Area (SOA). The CPL is non-adjustable.

CPL activity is indicated on the power output channel LED (embedded in the associated output channel's function button to the right of the LCD). Activity on an affected channel results in a flashing red indication together with a CURRENT CLIP warning message displayed on the screen adjacent to the LED. A warning is also displayed on the controlling PC via the network.

This condition indicates an attempt to draw excessive current at the output. The output is attenuated until the output current falls below the maximum current rating. Limiting is performed by the ISVPL limiter in conjunction with the selected ISVPL profile. Please refer to the Technical Specifications in chapter 11 for further details regarding ratings.



If excessive current is indicated, check the output cables and examine the loudspeaker. If impedance appears normal, you may rectify the condition by altering the ISVPL settings or lowering input levels. CPL indication can be triggered by excessively low output impedance, possibly the result of too many loudspeaker cabinets connected in parallel.

5.3.3 Power Average Limiter (PAL)

5.3.3.1 PLM 10000Q and PLM 14000

The Power Average Limiter (PAL) controls the AC current into the power supply. Power consumption is limited to the rated design parameters of the power supply, ensuring that the PSU will never be overloaded. Also, high-power products such as those in the PLM Series can potentially draw more current (with output devices still within safe operating areas) than is allowed by the external mains breaker.

The PAL protection feature can help prevent the supply's external breaker from tripping within time intervals of less than three minutes. For longer time intervals, it is the responsibility of the user to ensure that the average level of the audio is within limits that ensure that the breaker doesn't trip.

PAL activity is indicated by the LED within the first soft button adjacent to the display flashing red, together with a PAL ACTIVE warning message displayed on the screen. A warning is also displayed on the Lake Controller software.

5.3.3.2 PLM 20000Q

The Power Average Limiter Active warning (PAL Active) will be displayed when the power supply's maximum rated design parameters are reached. When this warning is displayed, gain limiting is being applied to the signal and the ISVPL threshold is lowered accordingly.

5.3.4 Breaker Emulation Limiter (BEL™)

The Breaker Emulation Limiter feature is present only in the PLM 20000Q. The PLM 20000Q is a powerful device that can draw a considerable amount of current from the mains supply. The BEL models the temperature in the external breaker and limits the mains current to prevent it from tripping. The BEL can be configured with both a breaker profile and a current value. The current value can be set from 5 to 32 Arms.

There are three different profiles available for selection:

- ▶ Conservative - The conservative profile allows no momentary current above the configured threshold.
- ▶ Fast - The fast profile models the time constant of the trip-curve corresponding to a fast breaker. It momentarily allows current above the threshold to pass for a short time, leading to an increased modeled temperature. For the limiter to disengage, the current must reduce below the threshold to enable the breaker to cool down.
- ▶ Universal - The universal profile models the time constant of the tripp-curve corresponding to a slow breaker. It momentarily allows current above the threshold for a longer time, leading to an increased modeled temperature. For the limiter to disengage the current has to reduce below the configured current for the breaker to cool down.

The BEL can be configured via the PLM front panel and via the Lake Controller.

5.3.5 Under Voltage Limiter (UVL™)

The PLM 20000Q is equipped with an under voltage limiter. With multiple powerful devices on a mains distribution line, heavy current loads risk the reduction of voltage below that required for devices to function. The PLM 20000Q's UVL reduces the mains current draw when voltage drop below 80 V. The amount of reduction applied increases as mains voltage drops towards 65 V, then at 65 V the power supply is shut down. The mains supply is continually monitored and when sufficient voltage returns the power supply automatically restarts.

5.3.6 Current Average Limiter (CAL™)

The Current Average Limiter (CAL) monitors the RMS current drawn from each power output channel to ensure that the power output stages are not overloaded. When activated, it regulates the current to a safe level to protect the channel. The CAL should not be activated in normal usage, but if it is, its operation is indicated by an active LED and the message CAL ACTIVE. Further indication is given within the Lake Controller software.

5.3.7 Voltage Clip Limiter (VCL)

If current draw from the PLM's power supply is too high, the PSU's regulation capability may be exceeded and the internal voltage rails may drop and cause clipping. If this occurs the VCL acts rapidly to prevent clipping on the subsequent peaks. Limiting is performed by the ISVPL limiter in conjunction with the selected ISVPL profile. Indication of this condition is shown on the output LEDs.

5.3.8 Temperature Protection

5.3.8.1 Overview

PLM Series devices are equipped with a sophisticated temperature sensing system that provides protection from overheating which may occur as a result of inadequate ventilation or excessive power output.

Thermal measurements are made at several points within each power output channel along with measurements in the power supply and DSP areas. If temperature in any area reaches a critical level then a warning is displayed and gain reduction is applied. If the temperature continues to increase and reaches a dangerous level then a fault is displayed and audio is muted. Each power output channel, the power supply and DSP area have separate indications.

For all temperature faults, temperature monitoring will continue at 0.5 second intervals, with the output remaining muted. When the area has cooled below the dangerous threshold, the fault condition is cleared and audio is restored.

5.3.8.2 Power Output Channels

A power output channel temperature warning or fault is indicated in one of the front panels LEDs (in the right-hand soft function buttons).

- ▶ A warning is indicated by a static yellow LED and adjacent warning message: TEMP WARN:CH
- ▶ A fault is indicated with a static red LED and adjacent warning message: TEMP FLT:CH

An event report is sent to the Lake Controller software for both the warning and the fault. If a temperature fault condition arises on a power channel, the output of that channel will be muted.

5.3.8.3 Power Supply / DSP

A power supply (PSU) or DSP temperature warning or fault is indicated by the LED in the top-left function button.

- ▶ A warning is indicated by a static yellow LED and adjacent warning message: TEMP WARN:PSU (or TEMP WARN:DSP)
- ▶ A fault is indicated with a static red LED and adjacent warning message: TEMP FLT:PSU (or TEMP FLT:DSP)

An event report is sent to the Lake Controller software for both the warning and the fault. If a temperature fault condition arises in the power supply the output of all channels will be muted. If a temperature fault condition arises in DSP area, audio will not be muted but continued operation is not recommended.

5.3.8.4 PLM 20000Q

For the PLM 20000Q a temperature dependant limiting feature is also present. At temperatures above the critical warning level and below the dangerous fault level, the ISVPL threshold is slowly reduced to decrease the output power and cool down the device. This enables the device to continue to pass audio, although with a reduced amplitude, in extreme conditions. If reducing the ISVPL threshold does not cool down the device a temp fault will still be issued when the dangerous temperature level is reached.

5.3.9 DC Protection

DC protection is implemented on each power output to prevent damage to connected loudspeakers or any PLM components. DC present at the output will cause the PLM's power output module breaker to blow. In this instance a red LED will illuminate and NEEDS SERVICE will display on the LCD.



The power output channel modules are independent of the input voltage. Both 115 and 230 V models have amp channel fuses. This is not a user-servicable fault condition and the unit should be returned for repair.

5.3.10 VHF Protection

The PLM includes protection circuits that detect Very High Frequency (VHF) content in the input signal. The detection is frequency-dependent, initiated from 10 kHz upwards. If VHF signals are detected above the threshold, the output will mute for approximately 6 seconds before a further measurement is taken. When continuous VHF signal stops, the output unmutes and the amplifier returns to normal operation.

This protection system recognizes that continuous VHF signals at high levels do not appear in speech or music. Any such content can therefore be considered as a fault condition. VHF protection is essential to avoid damage to HF drivers.

VHF protection is dependent on a combination of output power level and frequency. Figure 5-2 shows a decreasing power threshold, from approximately 10 kHz upwards, which illustrates increasing sensitivity of the protection system with frequency. When continuous output power above the threshold line is detected, VHF protection becomes active.

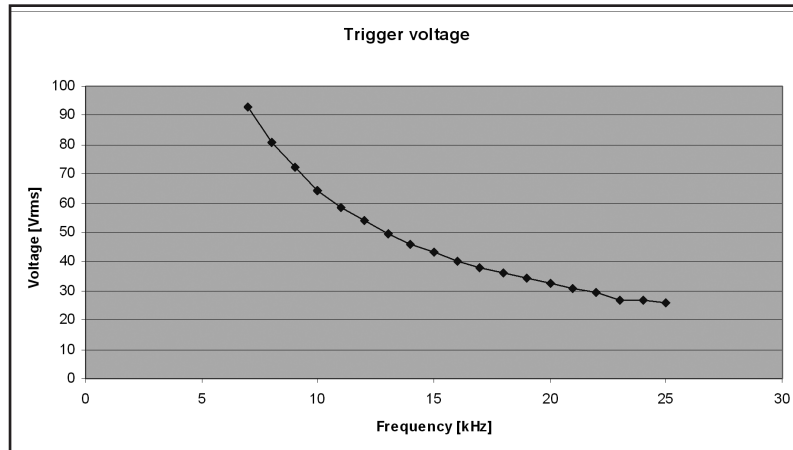

Figure 5-2: VHF Protection Frequency Sensitivity

The attack time of the VHF protection circuitry also changes with frequency, becoming shorter at higher frequencies. This is shown in Figure 5-3.

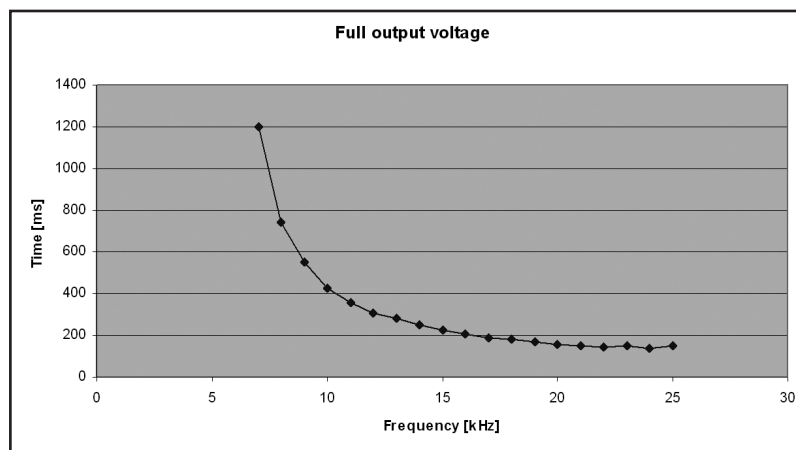

Figure 5-3: VHF Protection Attack Time Variations

The VHF protection circuit is NOT a limiter and does not alter the PLM's frequency response. It is implemented solely to detect continuous VHF content. HF content of normal music or speech signals at peak levels will be passed in full.

Operation of the VHF protection circuits is indicated by one (or more) of the output channel LEDs (in the right-hand soft function buttons) showing steady red. The adjacent fault message will show VHF FAULT. It is also reported as a fault via the control network.

5.3.11 Short Circuit Protection

A low impedance or short circuit at the power output terminals is detected when the output current is high (Current Peak Limiter is active) and, simultaneously, the peak output voltage is below a predetermined threshold (42 V with the PLM 10000Q, for example). When this situation occurs, the output stage is muted to protect it from damage. Operation of the short circuit protection system is indicated by an output channel LED (in the right-hand soft function buttons) showing steady red. The adjacent fault message will show SHORT CIRCUIT. It is also reported as a fault via the control network to the Lake Controller software. The presence of a short circuit (or low impedance) is re-tested every six seconds, and the output remains muted until the fault clears.

5.4 Power Supply

The R.SMPS (Regulated Switch Mode Power Supply) is designed to keep supply voltage rails at optimum levels even when the mains voltage drops. Mains voltages can drop as much as 20% below nominal before there is any effect on rail voltages. Thus the R.SMPS can deliver full rail voltage to the output stage at all times, allowing the PLM to exhibit consistent transient response and a clean LF response.

The PLM 20000Q is also equipped with a universal power supply with power factor correction (PFC). The device can take any mains voltage, from 65 V to 265 V, allowing it to function worldwide in many different configurations. The PFC reduces current peaks on the lines and reduces the requirements placed on the mains distribution system. The PLM 20000Q has an unparalleled power factor extremely close to one.

5.4.1 Low Inrush Current

High power amplifiers with inadequate inrush current limiting can draw considerable current from the mains at turn-on, sometimes tripping a fast-acting mains breaker. The PLM, however, has very low inrush current (the capacitors charge slowly and in a controlled manner) to prevent tripping of breakers.

Several PLMs can, under normal conditions, be powered up simultaneously. If you do experience problems powering up multiple PLMs simultaneously, they must either be turned on manually in an ordered manner, or sequenced remotely using the Lake Controller software's Global Control feature. Alternatively, the capacity of the mains supply should be increased.



If insufficient power is available to allow simultaneous power-up, then there is probably insufficient capacity for full power output during operation. It is recommended that additional capacity is added to the mains power distribution system.

6. Signal Flow and Lake® Processing

6.1 Signal Flow

Figure 6-1 and Figure 6-2 depict the audio signal flow inside a PLM. It is worth noting that this sophisticated device provides seven points in the signal chain where the signal level can be adjusted, muted or disconnected.

Important information regarding correct setting of the gain structure can be found in section 10.3.

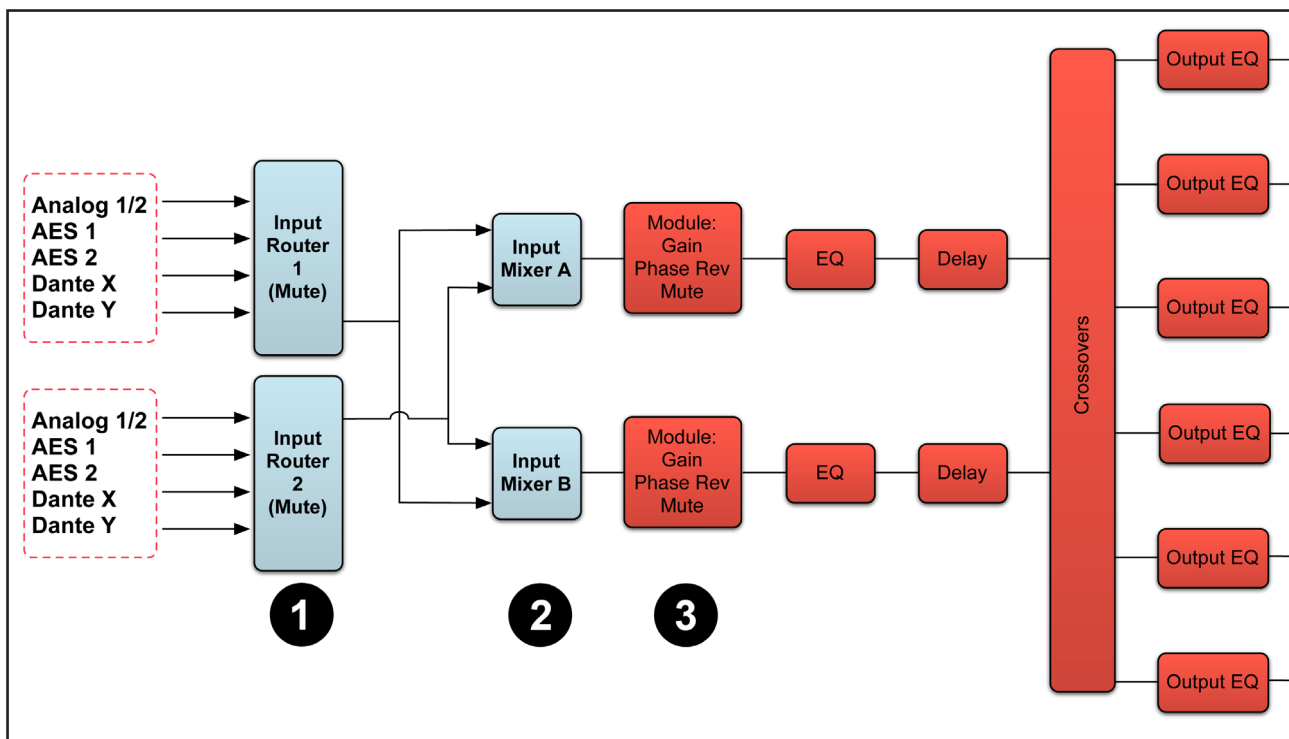

Figure 6-1: Signal Flow Diagram (PLM Series Part 1)

6.1.1 Level Adjustments & Mute Points

- ① Input Router Stage - Input selection and MUTE
- ② Input Mixer Stage - Router ON/OFF connection to mixer and gain settings
- ③ Module Input Stage - Mute and gain settings
- ④ Module Output Stage - Mute and gain settings
- ⑤ Output Router Stage - Output ON/OFF routing connections

- ⑥ Attenuation Stage - Power output channel mute and attenuation settings
- ⑦ Amp Gain Stage - Amplifier gain control



If the required audio signal is not passing correctly, verify the connection, mute and volume settings at all seven stages.

6.1.2 Power Output Section: Limiting and Sensitivity

The Current Peak Limiter (CPL) dynamically limits the drive to the power stage based on three parameters: sensed output current level, feedback from the output stage, and sensed voltage clip from the ISVPL. This ensures that power output is maintained within the design limits of the PLM.

The adjustable Inter-Sample Voltage Peak Limiter (ISVPL) sets the PLM's maximum output voltage and therefore also the maximum output power. The ISVPL setting is made via MENU > MODULE > LIMITERS > ISVPL, and can also be set from the Lake Controller software.

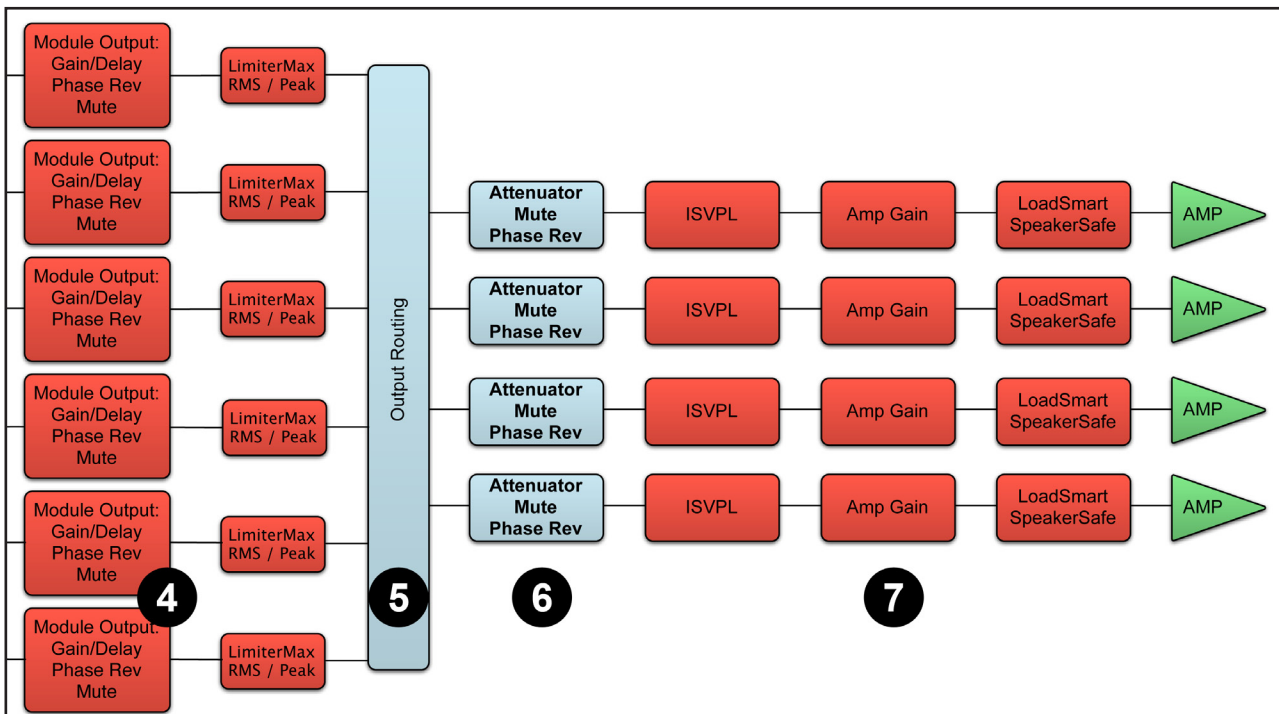

Figure 6-2: Signal Flow Diagram (4-channel PLM Part 2)

The sophisticated output section monitors faults and generates warnings when appropriate; warnings are displayed on the front panel of the PLM and also sent as messages over the control network. In the rare event that maximum ratings are significantly exceeded, the PLM will shut down until the condition has

been rectified or the incorrect setting has been readjusted. Sensing circuits also transmit local output power stage temperature, processor card temperature, and PSU temperature to the appropriate protection circuits. Please refer to section 5.3 on page 18 further details.

Table 6-1 lists PLM Series analog input sensitivity in dBu and Vrms for various Amp Gain settings and maximum/minimum ISVPL settings, assuming an analog input headroom of 26 dBu.

INPUT SENSITIVITY								
ISVPL SETTING	194 V		193 V		153 V		17.8 V	
GAIN (dB)	dBu	Vrms	dBu	Vrms	dBu	Vrms	dBu	Vrms
+44	+1.0	0.87	+0.9	0.86	-1.1	0.68	-19.8	0.08
+41	+4.0	1.22	+3.9	1.22	+1.9	0.96	-16.8	0.11
+38	+7.0	1.73	+6.9	1.72	+4.9	1.36	-13.8	0.16
+35	+10.0	2.44	+9.9	2.43	+7.9	1.92	-10.8	0.22
+32	+13.0	3.45	+12.9	3.43	+10.9	2.71	-7.8	0.32
+29	+16.0	4.87	+15.9	4.84	+13.9	3.84	-4.8	0.45
+26	+19.0	6.88	+18.9	6.84	+16.9	5.42	-1.8	0.63
+22	+23.0	10.90	+22.9	10.84	+20.9	8.59	+2.2	1.00

Table 6-1: Analog Input Sensitivity in dBu and Vrms

6.2 Lake Processing and Control

As outlined in section 2.2.3, this device integrates seamlessly into the Lake Processing environment, providing all features, functionality and connectivity associated with all Lake Processors. The internal Lake Processing includes programmable crossovers, EQ, dynamics and other functions, and can be fully controlled via the supplied Lake Controller software. Additionally, many functions can be controlled or accessed directly via the front panel.

The Lake Controller Operation Manual and Lake Network Configuration Guide are supplied on the accompanying CD-ROM and additional documentation is available from the Start Menu after software installation.

6.3 Modules and Frames

6.3.1 Overview

A Frame represents one physical Lake Processor (e.g. a PLM or LM 26). A maximum of two Modules are contained within each Frame; these are referred to as Module A and Module B. The number of Modules shown in a given Frame is dependent upon the signal processing configuration of that Frame.

Each Module can be configured as a Classic Crossover (Bessel, Butterworth, Linkwitz-Riley), as a Linear Phase Crossover, or as multiple full bandwidth Auxiliary Outputs. The default configuration for the PLM is 2 x 2-Auxiliary Output Modules, providing a total of four module outputs.

Please refer to the Lake Controller Operation Manual for further information.

6.3.2 LoadLibrary™ and Fingerprints

In addition to the standard loudspeaker presets (Module files), the Lake Controller also includes a set of enhanced Module files specifically for use with the PLM Series.

These supplementary PLM Module files, known as the LoadLibrary incorporate both Lake DSP parameters along with PLM specific data; LoadLibrary Module files include parameter settings for the PLM's Amplifier Gain and ISVPL limiter. Additionally, LoadLibrary loudspeaker types may also include data relating to the electrical characteristics of a particular loudspeaker.

Electrical characteristic data is used to enable load verification (LoadSmart) and monitoring facilities (SpeakerSafe) to be performed on the PLM. This data set is termed a Fingerprint. When a PLM-specific loudspeaker type is loaded, its Fingerprint load characteristics are included. These load characteristics are stored in a file with a ".mdl" suffix and are loaded simultaneously with the module file.

LoadLibrary Modules and standard Module files are cross-compatible, although when a LoadLibrary Module is loaded into a legacy Lake product the extra data within it is ignored.

6.3.3 Super Modules

Super Modules allow control of multiple Modules of the same type, distributed across multiple Frames, as a single entity within the Lake Controller software. A change made in the Super Module is replicated across all assigned Modules, resulting in improved efficiency in system configuration and a reduction of on-screen icons within the Lake Controller software.

The key benefit of this feature is the ability to connect and control crossovers, levels and EQ across multiple hardware devices simultaneously from the Lake Controller. For example, one device may be driving sub and low-frequency speakers, while another device controls mid-range and hi-frequency drivers. Using a single adjustment the crossover points between the two devices can be changed simultaneously.

Please refer to the Lake Controller Operation Manual for further information regarding Super Modules.

6.4 Loudspeaker Crossover Configuration Overview

The Lake Processing system within PLM Series devices may be configured with up to two inputs and up to six Module outputs, although the number of power outputs will be either two or four depending on the PLM model being used. To make use of the extra processing channels, multiple hardware devices may be connected together using the Super Module feature as summarized in section 6.3.3.

Each set of processing elements is referred to as a Module and can be configured as crossovers, full-bandwidth auxiliary outputs, or a combination of the two. The relationship between inputs and outputs is defined via the Lake Controller or via the front panel Input Config Menu.

The Lake Processing system provides two distinct categories of crossovers:

- ▶ Infinite Impulse Response filters (IIR) such as the classic Bessel, Butterworth or Linkwitz-Riley types; these are available with slopes ranging from 6 dB/octave to 48 dB/octave.
- ▶ Finite Impulse Response filters (FIR) providing zero phase shift with steep transition slopes at the crossover frequencies. These are also referred to as Linear Phase Crossovers.

Further details on these types of crossovers and information on configuring various module types can be found in the Lake Controller Operation Manual.

6.5 Files and Presets

The Lake system provides various methods for storing and recalling Module, Frame, or system-wide data. A overview is provided below; for further information please refer to the Lake Controller Operation Manual.

6.5.1 Module, System and Sub-System Configuration Files

Module, System and Sub-System Configuration files are stored on the Lake Controller PC, and data is passed across the network when recalling or storing these type of files.

- ▶ A Module file is the smallest set of data that can be stored and recalled; it contains crossover, gain, delay, and limiter information for an individual loudspeaker. A Module file may be recalled into other Lake devices. It is not possible to store a Module File directly on the hardware device.
- ▶ A System or Sub-System Configuration File contains a set of Module file information in addition to Frame related information such as I/O routing, along with Group control information.

6.5.2 Frame and System Presets

This device allows the complete processor configuration to be stored as a Frame Preset on the hardware unit itself. Presets can be recalled via the front panel (please refer to section 7.11.7) or via the Lake Controller software (please refer to the Lake Controller Operation Manual).

A maximum of 100 Frame Presets can be stored on this device. The data within a Frame Preset includes the configurations of both Modules in the Frame, including all levels, crossover, EQ, input mixer, output routing, and all other Module, Frame and Group parameters. As Frame Presets are stored in the device, complete processor configurations may be recalled without the need to connect the device to a PC.

Using the System Presets function in the Lake Controller, entire system configurations can be stored and recalled across a network of LM 26, PLM, Mesa Quad EQ, Contour Pro 26, and Dolby Lake Processors. This enables fast retrieval and switching of entire system configurations as minimal data is being sent between the Controller and Processors.

7. Front Panel Interface

An overview of the front panel interface is provided in section 4.1. This chapter describes each cluster of controls as shown in Figure 7-1.

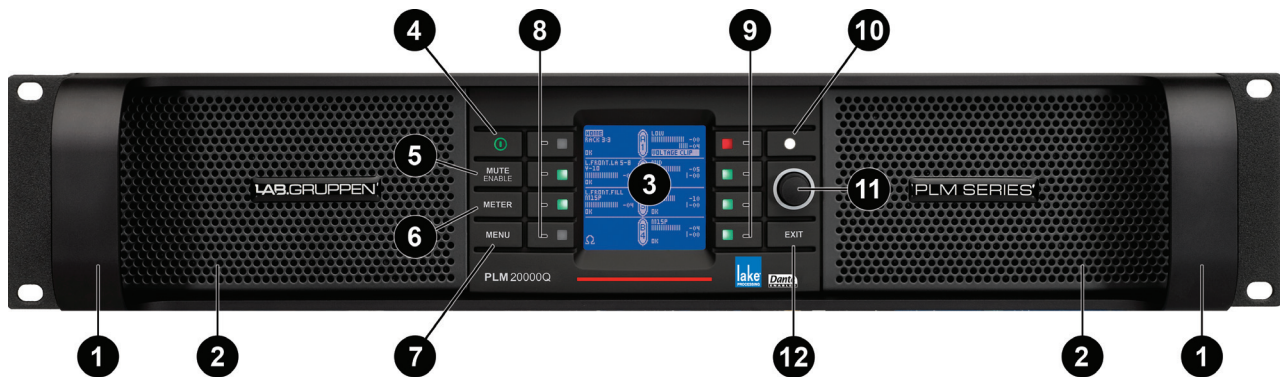

Figure 7-1: Front Panel Interface

7.1 Overview

The majority of PLM functions can be controlled and/or monitored via the front-panel LCD display screen **3**, function buttons **4 5 6 7 8 12** and rotary encoder **11**.

7.1.1 Operating Modes

The front panel has two basic modes: Meter Mode and Menu Mode.

- ▶ Meter Mode provides four views: Home View (default), Module View, Temperature View and Input View. To scroll through these views, press the METER button. Please refer to section 7.10 for further information on Meter Mode.
- ▶ Menu Mode provides various menus for viewing and editing parameters and is selected by pressing the MENU button. Select the required submenu by pressing the associated button. Please refer to section 7.11 for further information on Menu Mode.

7.1.2 Warning, Fault and Mute Indications

Fault or warning conditions are indicated via the tricolor LEDs embedded in the dynamic function buttons; a simultaneous description is shown adjacent to the button, on the LCD. The LEDs to the left of the LCD indicate problems with the PLM or its inputs, while those to the right indicate problems with the power output channels.

Please note that the same LEDs also indicate the mute status of inputs (left) and outputs (right). A full list, description and priority of the fault and warning indications is provided in section 7.8.5.2.

7.1.3 Highlighting a Module in the Lake Controller software via the PLM

It is sometimes useful to identify which Module icon/s in the Lake Controller software are associated with a particular hardware Frame. To highlight the module in the Lake Controller software:

1. Ensure Meter Mode is selected
2. Press the button adjacent to the Module description on the LCD

If the Frame is online, but the Module is not in the work area, the selected Module will be centred on the Module scroll bar (assuming the Modules Menu is selected in the Lake Controller).

7.2 Front Panel Key Lock

It is possible to lock the front panel buttons for security purposes. When this function is active, all front panel controls are disabled and all adjustment must be made via the network. To lock controls, press and hold button **A** then simultaneously press button **B** as shown in Figure 7-2; repeat this process to unlock.

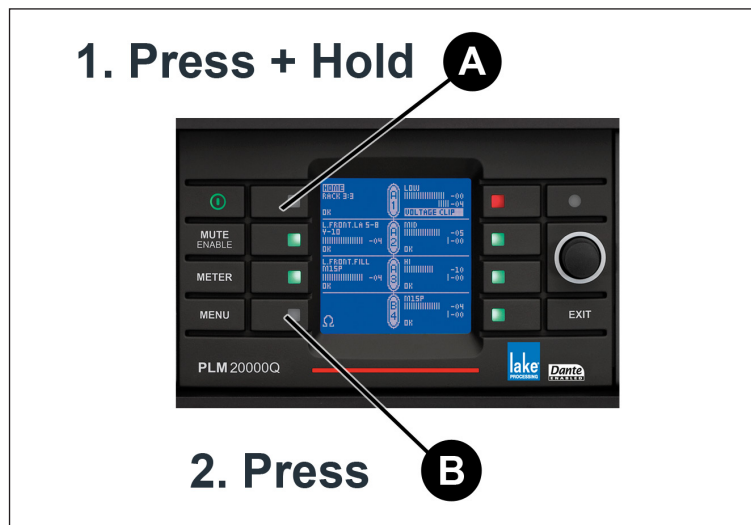

Figure 7-2: Locking / Unlocking Front Panel Controls

7.3 Power Button

The unit is powered on by pressing the top-left button on the front panel, labelled **4** in Figure 7-1. It has a bi-color power symbol which illuminates red when connected to the AC mains and the unit is in standby mode. It turns green when the button is pressed to turn the processor on. A subsequent press of this button returns the unit to standby mode.

7.4 Mute Enable Button

The dynamic function buttons to the immediate left and right of the LCD are used as MUTE buttons only when the MUTE ENABLE button **5** is activated (flashing).

When MUTE ENABLE is activated, the two central buttons on the left act as Module mute controls, and the four buttons on the right enable muting/unmuting of the power output channels.

In Meter Mode > Home View with MUTE ENABLE activated, text on the LCD adjacent to each button indicates when a Module input or power output has been muted. Meter Mode must be selected for MUTE ENABLE to be activated; MUTE ENABLE is not available in Menu Mode.

To exit MUTE ENABLE mode, press the flashing MUTE ENABLE button. If no mute activity occurs for two minutes, MUTE ENABLE mode will automatically be disabled.

7.5 Meter Button

The front panel display has two main operating modes, Meter Mode (default) and Menu Mode. In normal operation, the display will be in Meter Mode.

There are four views available in Meter Mode: Home View (default), Module View, Temperature View and Input View. Pressing the METER button **6** toggles between these views. Pressing the METER button when in Menu Mode will return the system to Meter Mode, with the Home View displayed. Please refer to section 7.10 for further information.

7.6 Menu Button

Menu Mode is selected by pressing the MENU button **7**. The screen displays the top level menu with various submenu options. Press the button adjacent to the required submenu to select it.

Pressing the MENU button while in Menu Mode will display the previous menu level.

Menu Mode is used for processor configuration, or for editing a parameter. Please refer to section 7.11 for further details.

7.7 Exit Button

In Menu Mode, pressing the EXIT button **12** returns back one menu level. In Meter Mode, pressing EXIT returns the display to the Home View.

7.8 Dynamic Buttons, Controls and LEDs

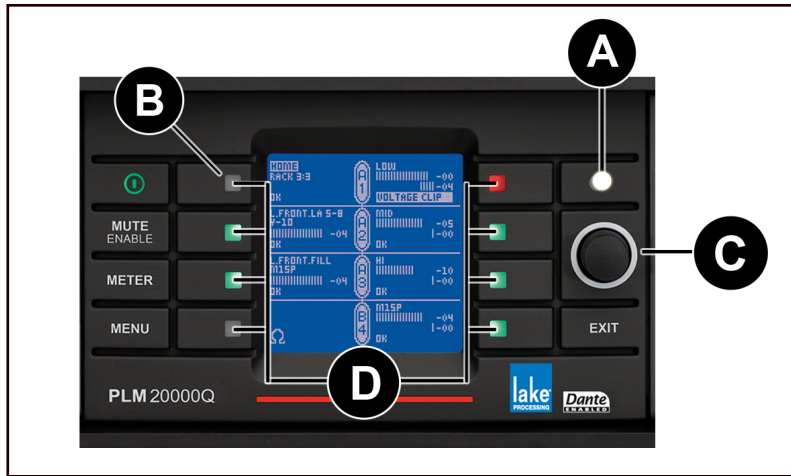

Figure 7-3: LCD with Dynamic Buttons, Controls and LEDs

7.8.1 Communication LED (A)

This bright white LED signifies selection in the Lake Controller, or Controller communication providing visual confirmation of:

1. Network communication between the Lake Controller and the Lake Processor (Flashing LED).
2. Selection of the Lake Processor in the Lake Controller software (Steady LED).



The Communication LED can be dimmed via the front panel by selecting Frame menu, and then Front - Dimming.

7.8.2 Frame Faults and Warnings LED (B)

This bi-color LED turns red to indicate a Frame fault and turns yellow to indicate a Frame warning. Additional clarification of the fault or warning is displayed in the LCD. All mute, fault and warning states displayed on the front panel are summarized in section 7.9.

Additional faults and warnings are reported in the Event Log of the Lake Controller only. All faults and warnings recorded in the Event Log are listed in section 9.1 along with scenarios that may have arisen to cause them.

7.8.3 Rotary Encoder **C**

The rotary encoder is used to adjust parameters in conjunction with the selection made via the dynamic function buttons and LCD menus. The ring around the rotary encoder illuminates when a selected parameter is available for adjustment.

Turn the encoder clockwise to increase the selected parameter, or counter-clockwise to decrease the value. Parameters with only two states (e.g. ON, OFF) are toggled by turning clockwise or counter-clockwise. Some parameters enable simultaneous adjustment of a combination of input and output channels.

To select which channels are adjusted:

1. Press the associated soft button/s to select the parameter/s for editing.
A selected parameter is indicated by inverse text and background color.
2. Use the rotary encoder to change the value.

It is possible to select multiple parameters for simultaneous editing even if the values are different on each channel. Turning the rotary encoder will adjust each parameter by the same increment. When in Meter Mode, the rotary encoder allows the user to change between the available meter views.



Some menus permit parameters to be adjusted across multiple channels simultaneously by default.

7.8.4 Dynamic Function Buttons **D**

The buttons surrounding the display are unlabeled because their functions change according to the currently selected menu or display.

In Meter Mode with MUTE ENABLE activated, these dynamic function buttons are used to mute or unmute the Module Inputs and power output channels.

In Menu Mode these buttons are used to navigate the menu structure. During menu navigation, the color of the embedded LEDs continue to indicate the mute status, or clips, faults and warnings relevant to the associated input or output channel on the PLM.



Each button contains a tricolor LED which conveys fault and warning indications in addition to the mute status. The LED color does not necessarily correspond to the currently selected function.

7.8.4.1 Mute Functions

The PLM provides mute functions at several different points in its audio chain. Please refer to section 6.1 for further information. The four types of mute are:

1. PLM Input Mute
2. Module Input Mute
3. Module Output Mute
4. Power Output Mute

With the exception of Module output mutes, all types may be controlled from the PLM front panel in Meter Mode by activating MUTE ENABLE and selecting the associated input or output Meter View using the METER button.



Module input and output mutes can be controlled in Menu Mode via the MENU button. All mutes can also be controlled from the Lake Controller.

7.8.4.2 PLM Input Mute

The PLM input mute provides the ability to simultaneously mute/unmute all modules or outputs that are sourced from the PLM input. To mute or unmute the PLM inputs:

1. Press METER until the Input Meter View is displayed
2. Press MUTE ENABLE
3. Use the associated dynamic function buttons to mute / unmute the PLM inputs



The PLM Input Mute is within the Lake Processing system, post input type selection, and pre input mixing and routing.

Please refer to the Lake Controller User Manual for details of mute selection via the software.

7.8.4.3 Module Input Mute

The Module input mute provides the ability to mute/unmute the audio signal at the module level. Therefore, the PLM input (described in 7.8.4.2) remains unmuted and can be used by another module, or directly routed to an output. To mute or unmute a Module input:

1. Press METER until Home View is displayed
2. Press MUTE ENABLE
3. Use the associated dynamic function buttons to mute / unmute the Module inputs

Once the Module input is muted, the LED turns red and MOD. IN MUTE is displayed on the LCD. When unmuted, the LED turns green (unless any other output warning conditions are active)..



Fault condition LED indications take priority over mute status indications. If a fault condition occurs, the LED will indicate the fault and not the mute status.

Module Input Mutes may also be controlled in Menu Mode. See section 7.11.2.6 for further details.

Please refer to the Lake Controller User Manual for details of mute selection via the software.

7.8.4.4 Module Output Mute

Module Output Mute is part of the Lake Processing system, at the crossover outputs. It is post Module output EQ and level adjustment, pre PLM's protection circuitry.

Muting of the Module outputs is unavailable via MUTE ENABLE in Meter Mode, as the PLM power output mutes are assigned in this mode (see section 7.8.4.5). However, Module output mute status and control is available in Menu Mode and may also be viewed and controlled from the Lake Controller software.

Please refer to section 7.11.2.6 for details of selecting Module Output Mute in Menu Mode.

Refer to the Lake Controller User Manual for details of mute selection via the software.

7.8.4.5 Power Output Mute

The four dynamic function buttons to the right of the LCD control the Power Output Mutes of output channels 1-4. These mutes are located within the PLM's power output stage.

When a PLM power output is muted, the LED turns red and the text AMP CH. MUTE is displayed on the LCD. When unmuted, the LED turns green (unless any other output warning conditions are active).



Fault condition LED indications take priority over mute status indications. If a fault condition occurs, the LED will indicate the fault and not the mute status.

7.8.5 LED Fault, Warning and Clip Indication B D

A tricolor LED is embedded inside each of the eight dynamic function buttons. These convey a variety of status indications including faults and warnings, signal clip indications, Module input mute, Module output mute and Power Output mute. Table 7-1 summarizes the meaning of the LED indications.

LED Color	Indication
Green	Status Good / Unmuted
Yellow	Warning
Red	Fault / Muted
Flashing Red	Clip

Table 7-1: LED Fault and Warning Indications



An unlit output LED indicates either the channel is not available for the model in use, or that the power output channel is not routed to a Module output channel.

7.8.5.1 Clip Indication

The front panel LEDs also indicate input and output clip or pre-clip conditions that can occur within the PLM.

Input Clip

Input clipping is monitored at two stages in the signal path:

- ▶ Analog Input Stage: If the input signal exceeds either +12 dBu or +26 dBu (according to analog sensitivity setting), a clip indication is displayed. Not applicable for AES or Dante inputs.
- ▶ Module Input Stage: If the signal level at this point exceeds +25 dBu, a clip indication is displayed.

Input clipping is indicated the affected Module LED flashing red and INPUT CLIP displayed on the LCD. If a subsequent input clip within 400 ms is detected, the LED remain lit for a longer period.

Output Clip

All output channels are monitored by a suite of protection circuits that include a Current Peak Limiter (CPL) and an Inter-Sample Voltage Peak Limiter (ISVPL). Please refer to section 5.3 for further information.

If CPL protection is active, or a voltage clip occurs, then the associated Power Output Channel LED will flash red and a text warning will also be displayed on the screen.

7.8.5.2 Warning or Fault Indications

If certain parameters within the PLM approach or exceed preset limits, a warning condition or fault condition may arise. One or more LEDs provide a visual indication of the problem, along with an on-screen description of the condition displayed adjacent to the LED/s.

- ▶ A green LED confirms inputs or outputs are unmuted and operating normally
- ▶ A yellow LED signifies a warning are reserved for PLM warnings
- ▶ A red LED indicates a fault, clip or mute

An Event Log file lists all warnings with date and time stamps, please refer to the Lake Controller Operation Manual for further information the Event Log.

Please refer to Table 7-2 and Table 7-3 below, and to Table 9-1 on page 76, for a detailed description of faults and warnings.

7.9 Warning and Fault Indications

Table 7-2 lists the warning conditions signified by a yellow LED; Table 7-3 lists the fault conditions signified by a red LED.

PLM Model	Warning	Type	LED No.	On Screen Warning Text	Event Log Text
20000Q	Amp Temp Limit	Frame	1	ATL ACTIVE	N/A
ALL	AES Clock Slipping	Module	1	CLOCK SLIPPING	AES Clock Slipping
ALL	Amp Temp Warning	Channel	5-8	TEMP WARN:CH	Temp warning: Amp Channel
20000Q	BEL Active	Frame	1	BEL ACTIVE	N/A
ALL	Controller Offline	Frame	1	CTRL OFFLINE	N/A
ALL	Frame Offline	-	1	OFFLINE	Frame Offline
ALL	Load Not Verified	Module Channel	2+3 5-8	LOAD NOT VER	LoadSmart: Load Not Verified
ALL	Load Uncertain	Channel	5-8	UNCERTAIN LOAD	Uncertain About Load Type
20000Q	PSU Mains Glitch	Frame	1	MAINS GLITCH	Glitch on Mains Voltage Detected
20000Q	PSU Power Limit	Frame	1	PAL ACTIVE	N/A
20000Q	PSU Temp Limit	Frame	1	PTL ACTIVE	N/A
ALL	PSU Temp Warning	Frame	1	TEMP WARN: PSU	Temp Warning: Power Supply Unit
ALL	Sense Fault	Frame	1	SENSE FAULT	Frame warning: Sense Fault
ALL	Speaker Mag Temp Warning	Channel	5-8	TEMP WARN:MAG	Temp Warning: Speaker Magnet
ALL	Speaker Over Count	Channel	5-8	OVER SPKR CNT	Over Speaker Count
ALL	Speaker Under Count	Channel	5-8	UNDER SPKR CNT	Under Speaker Count
ALL	Speaker VC Temp Warning	Channel	5-8	TEMP WARN:VC	Temp Warning: Speaker Voice-Coil
ALL	SpeakerSafe Not Started	Ch	5-8	SPKSAFE INACT	SpeakerSafe Not Started
ALL	SpeakerSafe Precision Low	Ch	5-8	LM PREC. LOW	SpeakerSafe Precision Low
20000Q	Under Voltage Limit	Frame	1	UVL ACTIVE	N/A

Table 7-2: Warning Conditions (Yellow LED)

PLM Model	Fault/Clip/Mute	Type	LED No.	On Screen Warning Text	Event Log Text
ALL	Amp Ch Mute	Channel	5-8	AMP CH. MUTE	Amp Channel Mute
ALL	Amp Temp Fault	Channel	5-8	TEMP FLT:CH	Temp Fault: Amp Channel
ALL	Analog Input Fault	Frame	1	ANALOG IN FAULT	Frame Fault: Analog Input
20000Q	Check AC Mains	Frame	1	CHECK AC MAINS	Frame Fault: Check AC Mains
ALL	Current Average Limiter	Channel	5-8	CAL ACTIVE	n/a
ALL	Current Protection Limiter	Channel	5-8	CURRENT CLIP	N/A
ALL	DSP Area Temp Fault	Frame	1	TEMP FLT:DSP	Temp Fault: DSP Area
ALL	Input Channel Mute	Inp.Mix	2+3	INPUT MUTE	Input Mute
ALL	Internal Audio Interface Fault	Frame	1	AUDIO FAULT	Frame Fault: Audio Interface
ALL	Module Input Mute	Module	2+3	MOD. IN MUTE	Module Input Mute
ALL	Module Output Clip	Module	2+3	MOD. CLIP	n/a
ALL	Module Output Mute	Channel	5-8	MOD. OUT MUTE	Module Output Mute
ALL	No input source available	Module	2+3	NO INPUT	No Input Source
ALL	No Load Detected at Output	Channel	5-8	NO LOAD	Channel Fault: No Load Detected
ALL	Physical Input Clip	Module	2+3	INPUT CLIP	n/a
ALL	Power Average Limiter	Frame	1	PAL ACTIVE	n/a
ALL	Power Channel Failure	Channel	5-8	SERVICE CH.	Channel Fault: Unit Needs Service
ALL	PSU Area Temp Fault	Frame	1	TEMP FLT:PSU	Temp Fault: Power Supply Unit
ALL	PSU Fault / Undervoltage	Frame	1	PSU FAULT	Frame Fault: PSU Undervoltage
20000Q	PSU Mains Over Voltage Peak	Frame	1	MAINS >400 VPK	Frame Fault: PSU Mains >400 VPK
20000Q	PSU Mains Over Voltage RMS	Frame	1	MAINS >270 V	Frame Fault: PSU Mains >270 V
20000Q	PSU Mains Under Voltage	Frame	1	MAINS <65 V	Frame Fault: PSU Mains <65 V
20000Q	PSU Needs Service 1	Frame	1	NEED SERVICE:1	Frame Fault: Need Service: 1
20000Q	PSU Needs Service 2	Frame	1	NEED SERVICE:2	Frame Fault: Need Service: 2
20000Q	PSU Needs Service 3	Frame	1	NEED SERVICE:3	Frame Fault: Need Service: 3
20000Q	PSU Needs Service 4	Frame	1	NEED SERVICE:4	Frame Fault: Need Service: 4
20000Q	PSU Needs Service 5	Frame	1	NEED SERVICE:5	Frame Fault: Need Service: 5
20000Q	PSU Needs Service 6	Frame	1	NEED SERVICE:6	Frame Fault: Need Service: 6
20000Q	PSU Needs Service 7	Frame	1	NEED SERVICE:7	Frame Fault: Need Service: 7
20000Q	PSU Needs Service 8	Frame	1	NEED SERVICE:8	Frame Fault: Need Service: 8
20000Q	PSU Rail Protect	Frame	1	PSU POWER PROT	Frame Fault: PSU Power Protect
ALL	Short Circuit Protection	Channel	5-8	SHORT CIRCUIT	Channel Fault: Short Circuit Protection
ALL	Speaker Magnet Temp Fault	Channel	5-8	TEMP FLT:MAG	Temp Fault: Speaker Magnet
ALL	Speaker VC Temp Fault	Channel	5-8	TEMP FLT:VC	Temp Fault: Speaker Voice Coil
ALL	VHF Protection	Channel	5-8	VHF FAULT	Channel Fault: Very High Frequency
ALL	Voltage Protection Limiter	Channel	5-8	VOLTAGE CLIP	n/a
ALL	Wrong Type of Speaker	Channel	5-8	WRONG LOAD	Load Type / Routing Mismatch

Table 7-3: Fault Conditions (Red LED)

7.10 Meter Mode

7.10.1 Home View

The default view when powering on the device is Meter Mode > Home View as shown in Figure 7-4.

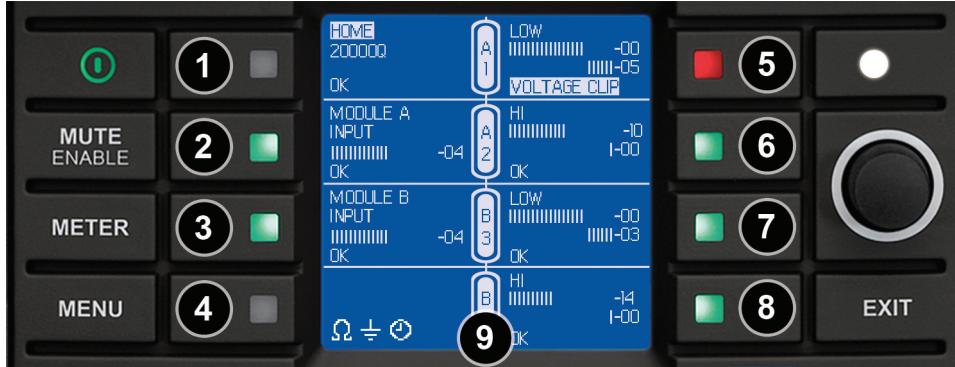

Figure 7-4: Meter Mode > Home View

Home View provides a summary of Module I/O gain level and limiter gain reduction, along with frame, module and channel labeling information. The example in Figure 7-4 shows a stereo 2-Way, with Module A (Input 1) feeding power output channels 1&2, and Module B (Input 2) feeding power output channels 3&4.

- ❶ Current View title & Frame label, Frame faults and warnings.
- ❷ Module A label, input gain meter, faults, warnings, clips & mutes.
- ❸ Module B label, input gain meter, faults, warnings, clips & mutes.
- ❹ This section displays confirmation of the following settings:
 - Ω AES3 Input Terminated (no icon = Unterminated)
 - ⊥ Analog Inputs Iso-Float Grounded (no icon = Floating)
 - ⌚ Dante Clock Master (no icon = Dante Slave or Dante Disabled)
- ❺ Power output 1 label, gain & limiter meters, faults, warnings, clips & mutes.
- ❻ Power output 2 label, gain & limiter meters, faults, warnings, clips & mutes.
- ❼ Power output 3 label, gain & limiter meters, faults, warnings, clips & mutes.
- ❽ Power output 4 label, gain & limiter meters, faults, warnings, clips & mutes.

Please refer to Table 7-2 and Table 7-3 on page 41 for full details on the faults and warnings that could be displayed in any of the above locations.



Output limiter (gain reduction) meters take into account the sum of PLM ISVPL and Lake LimiterMax.

9 The icons in the center of the LCD indicate the amplifier channel to which each module output is routed. When two amplifier channels are Bridged, both channels will be displayed.

The type of icon used in the center of the screen 9 confirms whether the PLM outputs are configured in Standard mode or Bridge Mode, as shown in Figure 7-5. For further information on Bridge Mode, please refer to section 8.1.1.



Figure 7-5: Standard and Bridge Mode Front Panel Icons

Bridge Mode is visible via this icon notation on the PLM Front Panel in Home View, however, the Lake Controller must be used to configure Bridge Mode; please refer to the Lake Controller Operation Manual for further information.

Home View looks similar for most configurations, with slight variations dependant on the PLM model and processor configuration.

7.10.2 Module View

Module View provides further signal level information in the form of additional power output meters as shown in Figure 7-6.

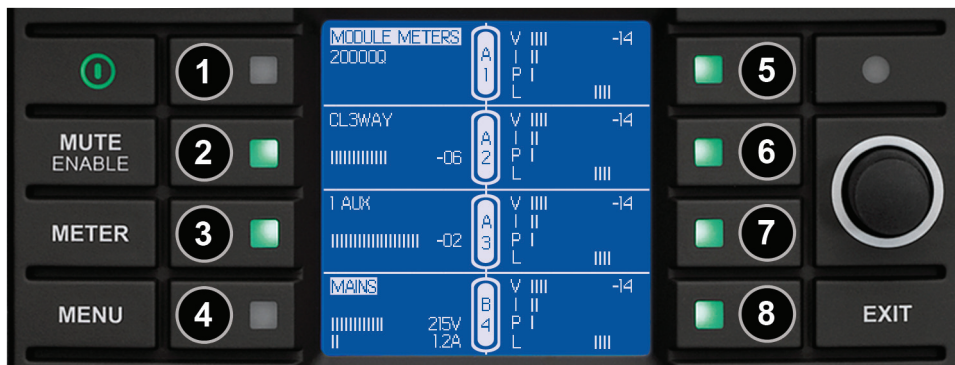

Figure 7-6: Meter Mode > Module View

- 1 Current View title & Frame label, Frame faults and warnings
- 2 Module A label and input gain meter

- ③ Module B label and input gain meter
 - ④ Main Voltage and Ampere Meter (PLM 20000Q ONLY)
 - ⑤ Output 1: V - Voltage Meter I - Current Meter P - Power Meter L - Gain Reduction Meter
 - ⑥ Output 2: V - Voltage Meter I - Current Meter P - Power Meter L - Gain Reduction Meter
 - ⑦ Output 3: V - Voltage Meter I - Current Meter P - Power Meter L - Gain Reduction Meter
 - ⑧ Output 4: V - Voltage Meter I - Current Meter P - Power Meter L - Gain Reduction Meter
- ▶ The Voltage Meter (V) indicates the PLM's power output stage voltage relative to its clip level
 - ▶ The Current Meter (I) indicates the current the power output stage is driving into its load, relative to the maximum permissible current the fixed CPL allows
 - ▶ The Power Meter (P) indicates the instantaneous output power being developed in the load relative to the PLMs maximum output power capability.
 - ▶ The Gain Reduction Meter (L) indicates the degree of limiting being applied by the PLM ISVPL and/or the Lake LimiterMax.

7.10.3 Temperature View

Temperature View provides information about the current operating temperatures within the PLM and the connected loudspeakers.

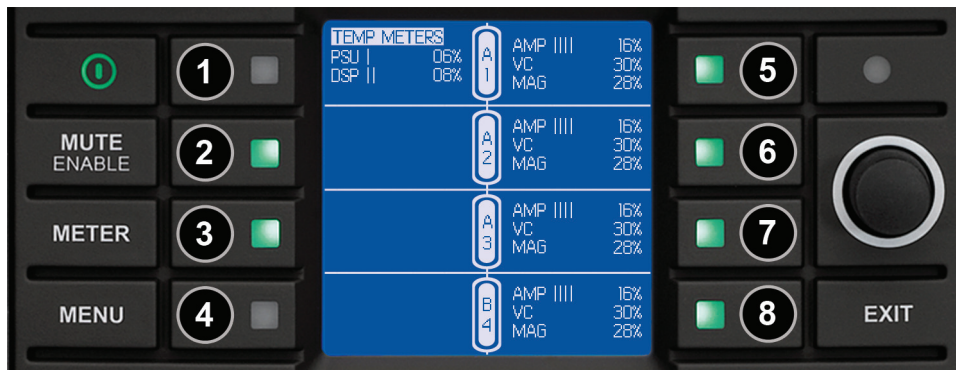

Figure 7-7: Meter Mode > Temperature View

- ① Current View title. Power supply temp (PSU) & Lake processor temp (DSP) as percentage of maximum
- ② Unused in Temperature View
- ③ Unused in Temperature View

- ④ Unused in Temperature View
 - ⑤ Output 1: AMP - Temp of power output VC - Temp of voicecoil MAG - Temp of magnet
 - ⑥ Output 2: AMP - Temp of power output VC - Temp of voicecoil MAG - Temp of magnet
 - ⑦ Output 3: AMP - Temp of power output VC - Temp of voicecoil MAG - Temp of magnet
 - ⑧ Output 4: AMP - Temp of power output VC - Temp of voicecoil MAG - Temp of magnet
- ▶ AMP indicates the current actual temperature of that channel's power output stage as a percentage of its maximum permitted value. The numerical value is in dB relative to signal clip.
 - ▶ The computed temperature of voice coil (VC) of the loudspeaker connected to that output channel. This parameter is calculated using the power currently being dissipated in the load, and by using the loudspeaker data from the LoadLibrary Fingerprint as presented by the SpeakerSafe output. The numerical value is displayed in degrees Celsius.
 - ▶ The computed temperature of the magnet (MAG) of the loudspeaker connected to the output channel. This parameter is calculated and displayed in a similar way to the voice coil (VC) temperature.

7.10.4 Input View

Input View enables inspection of the input signal before the input mixer (i.e. prior to the Home View Module input meters).

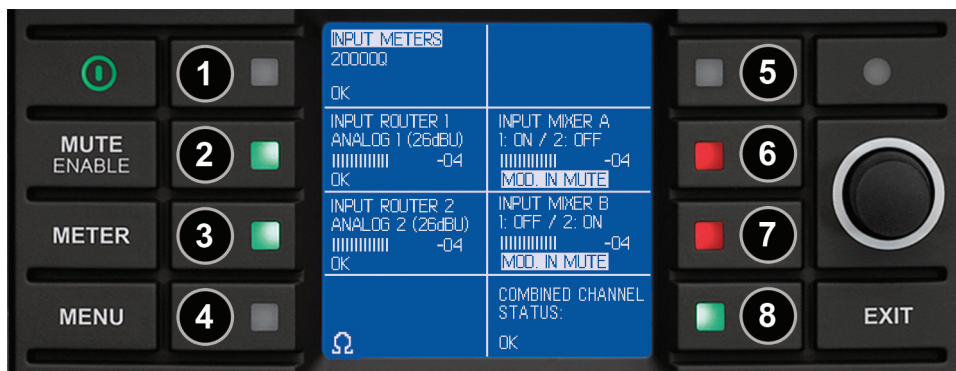

Figure 7-8: Meter Mode > Input View

- ① Current View title & Frame label, Frame faults and warnings
- ② Input Router 1: Selected input type, input gain level (relative to clip), router fault/warning/clip
- ③ Input Router 2: Selected input type, input gain level (relative to clip), router fault/warning/clip
- ④ This section displays confirmation of the following settings:

Front Panel Interface

- Ω AES3 Terminated Icon (no icon = AES Unterminated)
- ⊕ Iso-Float Grounded Icon (no icon = Iso-Float Floating)
- 🕒 Dante Clock Master Icon (no icon = Dante Slave or Dante Disabled)

- 5 Unused in Input View
- 6 Module A Input Mixer: Input 1/2 Connection Status, Module A input level meter
- 7 Module B Input Mixer: Input 1/2 Connection Status, Module A input level meter
- 8 Combined channel status summarizing faults and warnings for all power outputs

7.11 Menu Mode

7.11.1 Overview

The majority of functions can be accessed via Menu Mode on the front panel. These functions include the adjustment of gain, delay, limiters, input and output routing, and the ability to recall Frame Presets. Menu Mode can be accessed at any time by pressing the MENU button.

After pressing the MENU button, various submenu options are displayed as shown in Figure 7-9.



Figure 7-9: Menu Mode > Main Menu

Press the illuminated button adjacent to the required option to display an associated submenu. When parameter level is reached, individual parameters may be selected for adjustment by pressing the adjacent button. The selected parameter value/s are highlighted, and are adjustable using the rotary encoder.

A parameter may be adjusted simultaneously across multiple channels by selecting all values to be adjusted; any current value offsets are retained. Some parameters default to multiple selection, with all inputs or outputs adjusted simultaneously. Changes are effected in real-time and are stored without further confirmation. Pressing EXIT returns to the previous menu level, automatically retaining any parameter changes.



All parameters are editable via the Lake Controller unless specified otherwise.

7.11.1.1 Parameters with Individual Values and Group Totals

The following parameters display two values:

- ▶ MODULE > GAIN
- ▶ MODULE > DELAY
- ▶ MODULE > LIMITERS > MAXRMS LEVEL
- ▶ MODULE > LIMITERS > MAXPEAK LEVEL

The Module parameter can be adjusted using the rotary encoder. The Group total (shown in brackets) is only adjustable using the Groups function in the Lake Controller.

The Group total is the sum of the individual Module value plus any values for this parameter on all Groups to which the Module is assigned. Please refer to the Lake Controller Operation Manual for further information on Groups.

7.11.1.2 Menu Structure Overview

From the Main Menu, the following submenus are available, as shown in Figure 7-9 and described in the following sections.

- ▶ MODULE (See section 7.11.2)
 - ▶ Gain
 - ▶ Delay
 - ▶ Polarity
 - ▶ Amp Gain
 - ▶ Limiters
 - ▶ Mute
- ▶ INPUT CONFIGURATION (See section 7.11.3)
 - ▶ Router 1
 - ▶ Router 2
 - ▶ AES Termination
 - ▶ Iso-Float
- ▶ ATTENUATION (See section 7.11.4)

- ▶ FRAME (See section 7.11.5)
 - ▶ Frame Information
 - ▶ Frame Reset
 - ▶ Network
 - ▶ Latency Match
 - ▶ Front Panel

- ▶ FRAME PRESETS (See section 7.11.7)
 - ▶ Preset Recall

- ▶ LOAD MONITOR (See section 7.11.8)
 - ▶ Configure No. of Cabinets in Parallel
 - ▶ LoadSmart Verification
 - ▶ Estimated No. of Cabinets

- ▶ DANTE (See section 7.11.9)



For simplicity, the following sections refer to the buttons by their associated name on the LCD screen. E.g. 'Press GAIN' equates to 'Press the button adjacent to the Gain label on the LCD'.

7.11.2 Module Submenu

MENU > MODULE

After selecting the Module Menu, the screen shown in Figure 7-10 is displayed. Press the illuminated button adjacent to the required option to view or edit the associated parameters.



Figure 7-10: Module Submenu

7.11.2.1 Gain

MENU > MODULE > GAIN



Figure 7-11: Module Gain Edit Screen

Press the illuminated button next to the input/s and/or output/s for adjustment, and use the rotary encoder to change the value/s. Multiple gain values may be adjusted simultaneously in 0.1 dB increments, subject to defined level limits.

7.11.2.2 Delay

MENU > MODULE > DELAY

Press the illuminated button next to the input/s and/or output/s for adjustment, and use the rotary encoder to change the value/s. Multiple delay values may be adjusted simultaneously in 0.1 ms increments, subject to defined level limits.

The audio signal may be delayed (typically for reasons of driver or delay subsystem alignment) at either the Module inputs or on individual outputs. Delay added at the inputs affects all outputs equally, and will be generally be introduced to time-align arrays of loudspeakers at different locations. Delaying individual outputs may be desirable to time-align drivers in the same cabinet or array.

7.11.2.3 Phase (Polarity)

MENU > MODULE > PHASE

Press the illuminated button next to the input/s and/or output/s to be adjusted, and use the rotary encoder to change the value/s. Phase may be changed on one input or output at a time.

Audio phase reversal is available at the inputs to Module A and Module B, and also individually on the six output channels. The LCD displays 'Positive' for normal operation, and 'Negative' when the phase is inverted.

7.11.2.4 Amp Gain

MENU > MODULE > AMP GAIN

By default, all outputs are selected; use the rotary encoder to change the gain of all power outputs or press the associated output button to deselect one or more outputs.

Amp Gain adjusts the gain of the PLM's power output stage for each output channel. The default setting is 35 dB, variable in 0.1 dB increments from 22 dB to 44 dB. Care should be taken in altering Amp Gain, which should be adjusted in conjunction with the Gain controls and limiter thresholds.

7.11.2.5 Limiters

MENU > MODULE > LIMITERS

Various parameters of the PLM's Inter-Sample Voltage Peak Limiter (ISVPL) and the Lake LimiterMax parameters can be adjusted via this submenu. By default, simultaneous adjustment of most limiter parameters across all output channels is selected, although channels may be adjusted individually if required. Attack and Release times must be adjusted individually per channel.

Inter-Sample Voltage Peak Limiter Threshold (ISVPL Threshold)

The ISVPL prevents the voltage of the PLM outputs from exceeding a pre-determined value. The ISVPL Threshold can be adjusted between 17.8 V to 600 V, which represents the instantaneous peak voltage, not the RMS value of the output signal. The actual value is displayed in brackets and can be limited by the maximum voltage a particular PLM Series model can produce.

Inter-Sample Voltage Peak Limiter Profile (ISVPL Profile)

Selecting the ISVPL Profile will optimize the ISVPL limiting for the specific frequency band. ISVPL Profile permits individual adjustments per channel between six profiles, providing appropriate attack and release times for the ISVPL Limiter and Voltage Clip feedback to either minimize distortion or maximize SPL as described below.

1. Universal – Optimized for low distortion, usable for all frequencies
2. Sub/LF – Optimized for higher SPL below 600 Hz, usable for all frequencies
3. Sub – Optimized for high SPL, 20-200 Hz
4. LF – Optimized for high SPL, 20-1200 Hz
5. MF – Optimized for high SPL, 300-6000 Hz
6. HF – Optimized for high SPL, > 1 kHz

The default ISVPL Profiles differ depending on the PLM Series model:

- ▶ PLM 10000Q / 20000Q: UNIVERSAL
- ▶ PLM 14000: SUB/LF

MaxPeak Level (MaxPeakLvl)

This sets the maximum peak signal level at the Module outputs. It is adjustable from -30 dBu to +30 dBu in 0.1 dB increments, subject to user-defined level limits. The Group total is displayed (in brackets) for each channel.

MaxRMS Level (MaxRMSLvl)

This sets the maximum RMS signal level at the Module outputs. It is adjustable from -30 dBu to +30 dBu in 0.1 dB increments, subject to user-defined level limits. The Group total is displayed (in brackets) for each channel.

MaxRMS Corner (MaxRMSCor)

A soft-knee or hard-knee corner may be applied to the RMS Limiter. A soft-knee corner gently increases limiting as the signal approaches the threshold; a hard-knee corner applies full limiting to any signal exceeding the threshold by any amount, but none to signals below the threshold.

The Corner parameter is adjustable in 0.1 dB increments, subject to defined level limits. This figure represents the level below the limiter threshold at which compression commences; the larger this negative value, the softer the knee. A setting of 0 dB implies a hard-knee characteristic.



LimiterMax provides peak and RMS limiting features, referred to as MaxPeak and MaxRMS respectively. Full details regarding LimiterMax can be found in the Lake Controller Operation Manual.

7.11.2.6 Mutes

MENU > MODULE > MUTES

In Meter Mode, Module inputs and PLM power output channels can be muted using the MUTE ENABLE function. The MUTE menu also provides mute status and control of the Module input mutes, but instead of the PLM power output channel mutes, it provides the ability to mute the Lake Module outputs.

Press the associated dynamic function button/s to select the Module input/s and/or Module output/s to be adjusted. Use the rotary encoder to toggle between the MUTED and UNMUTED states.

7.11.3 Input Config Submenu

MENU > INPUT CONFIG

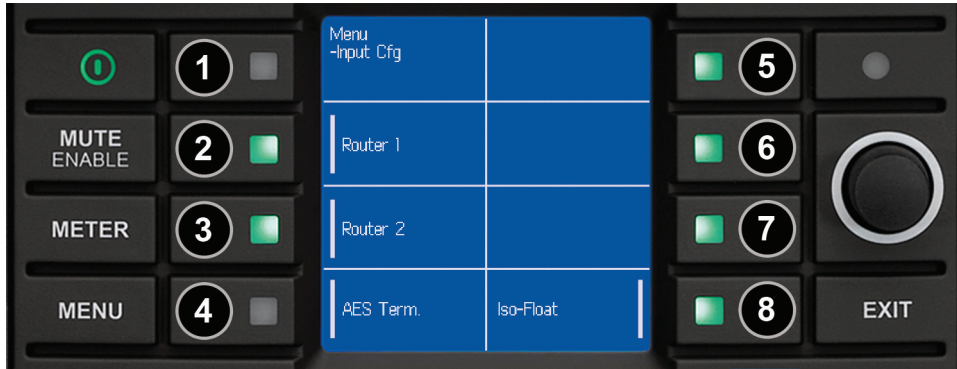

Figure 7-12: Input Config Submenu

This menu provides configuration options for input routing, along with settings for AES Termination and Iso-Float as described in the following sections.

7.11.3.1 Router 1 / 2

MENU > I/O CONFIG > ROUTER 1 / 2

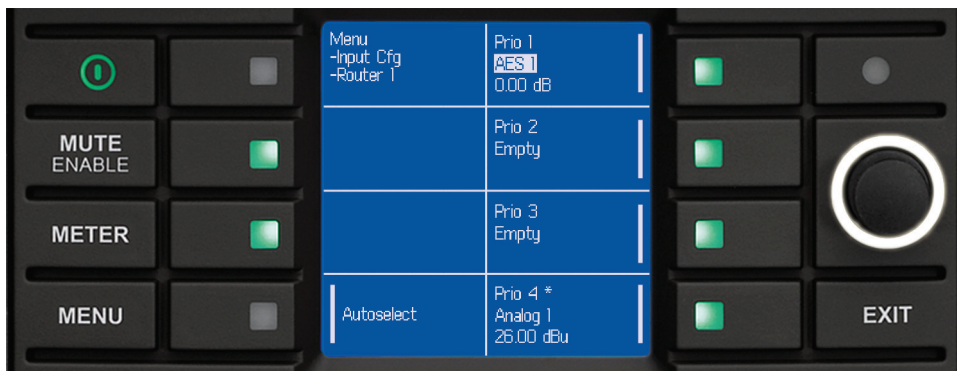

Figure 7-13: Input Router 1

Figure 6-1 on page 26 shows that there are two Input Routers available on PLM Series devices. The input that is selected within the router can be used by the input mixer for either Module A or Module B.

Each router has four priority levels allowing any input to be placed in a sequence providing automatic input signal fail over. AES3 and Dante inputs have priority over analog inputs.



Only one analog input is allowed in each router, and the analog input must be at the lowest priority level in relation to any other inputs.

Two modes of input selection are available, Auto Select and Forced Selection. The selected setting is also visible from the I/O STATUS screen on the front panel, and via the Lake Controller.

In Auto Select mode, Priority 1 is checked for a valid input signal; if no signal is found, Priority 2 is checked, and so on until a valid signal is located; this process occurs if the currently selected input fails. In Forced Selection mode, one of the four priorities is fixed regardless of whether a valid signal is present.

With a router selected on the front panel, press the middle button on the left of the LCD to activate this parameter for editing; the text will be highlighted as shown in Figure 7-13. Use the illuminated rotary encoder to scroll through the following options:

- ▶ Auto Select (default)
- ▶ Force Priority 1
- ▶ Force Priority 2
- ▶ Force Priority 3
- ▶ Force Priority 4

Assignment of Input Priority

Factory default settings assign AES3 to Priority 1 and Analog to Priority 4, with Priority 2 and 3 empty.

To change these settings via the front panel, select Priority slot number to be changed and use the rotary encoder to scroll through the available options. Due to the signal hierarchy it is not possible to assign an analog source to a higher priority than a digital source.

Analog Input Sensitivity and Digital Gain Offset

Press a dynamic function to the right of the LCD to toggle the selection of input source and input sensitivity/digital gain offset then use the rotary encoder to change the parameter.

The maximum input level accepted by the analog input pre-amplifiers without clipping may be set to 12 dBu or 26 dBu. Digital gain offset may be applied to AES3 digital input signals in 0.1 dB increments from -100 dB to +15 dB.

7.11.3.2 AES3 Input Termination

MENU > I/O CONFIG > AES TERM

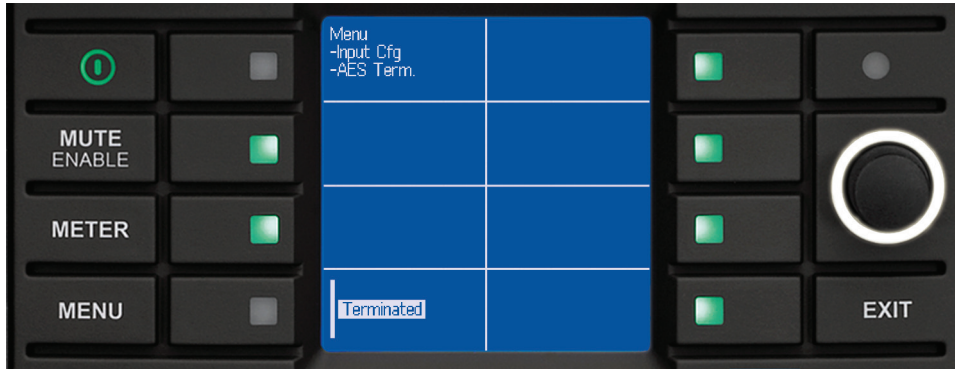

Figure 7-14: AES Termination Edit Screen

To adjust the AES3 Input Termination, select AES TERM from the Input Config menu then use the rotary encoder to toggle the value. An icon is displayed in the bottom left of the display in Meter Mode when AES is set to 'Terminated'.

For fault-free operation when using AES3 digital audio as an input source, inputs must be correctly terminated with the characteristic impedance of 110 ohm. The Input Termination setting is determined by the method used to distribute the AES3 signals.

The processor at the end of a distribution line should be set to TERMINATED; all other processors should be set to UNTERMINATED. If an AES3 distribution amplifier (DA) is being used to distribute the digital audio signals, with one DA output per processor, then all terminations should be on. However, if the AES3 is daisy-chained, only terminate the last processor in the chain.

7.11.3.3 Iso-Float

MENU > I/O CONFIG > ISO-FLOAT

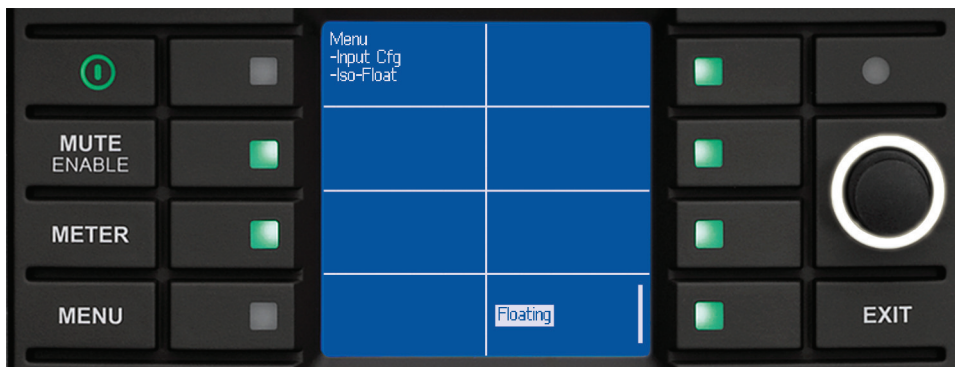

Figure 7-15: Iso-Float Menu

To change the Iso-Float setting, adjust the value using the rotary encoder. The current settings are also displayed on the front panel I/O STATUS screen.

The analog inputs utilize Iso-Float transformerless electronic balancing circuitry. This provides electrical isolation from an analog source comparable to that achieved with transformer-based designs. However, pin 1 of the XLR input connector may be connected to ground within the PLM if desired. This option is selected by using the rotary encoder to toggle between FLOATING and GROUNDED.

It may be necessary to change this setting to resolve ground loop problems when using analog inputs.

7.11.4 Attenuation Submenu

MENU > ATTENUATION

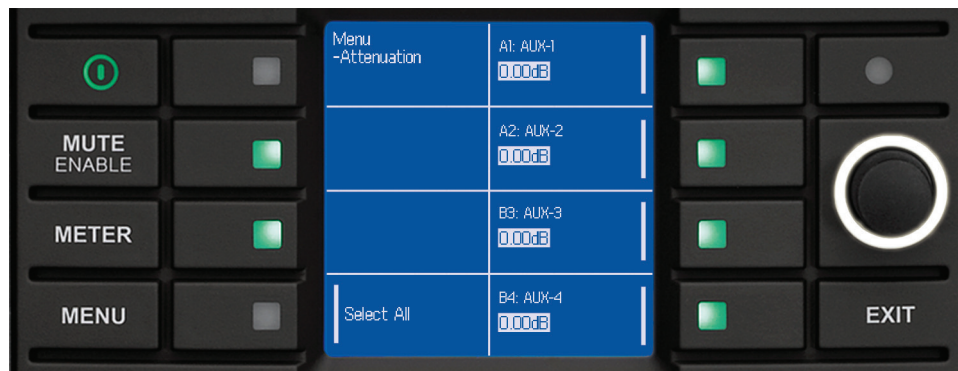

Figure 7-16: Attenuation Menu

The default setting of 0.00 dB (i.e. no attenuation) is adjustable in 0.25 dB increments down to -100 dB.

Adjustment of attenuation at the input to the PLM power stage is available on a per-channel basis. This adjustment is the PLM equivalent of a conventional amplifier level control. The power output channels may be turned down using these parameters before powering on or off. Please refer to the signal flow diagram in Figure 6-2 on page 27.

By default, all channels are deselected. Press the SEL ALL button to select/deselect all channels (as shown in Figure 7-16) or, press a single button on the right to adjust a channel individually.



For 4-channel PLMs, only ONE channel or ALL channels may be adjusted. It is not possible to adjust only two or three channels.

7.11.5 Frame Submenu

MENU > FRAME



Figure 7-17: Frame Menu

The Frame Menu provides information and options relating to the PLM as a physical unit. It is referred to as a Frame for consistency with Lake Controller terminology.

The Frame Label as defined in the Lake Controller is displayed in this menu. It is also displayed at the top-left of the screen in Meter Mode, Home View.

7.11.5.1 Frame Info

MENU > FRAME > FRAME INFO

Frame Info provides information about the device settings and configuration. All data in this front panel menu is read-only; some parameters are fixed, some can be changed only via the Lake Controller software.

Firmware Version (FW Version)

This option displays the version numbers for various firmware elements. This information can be used to verify that the latest firmware is installed and is useful if a technical issue arises.

Inherent Latency (Inh. Latency)

This option displays a screen showing latency currently incurred through the PLM, measured from input to output.

Processing of digital audio necessitates a small but finite processing delay referred to as system latency. It may be desirable to know the latency, so the value can be subtracted from any deliberate delay introduced for loudspeaker time-alignment. In many cases, the system latency is so small compared to time-alignment delay that it can be ignored.

Serial Number (Serial No.)

The printed serial number on the back panel of the PLM is also electronically embedded in the hardware, and therefore cannot be removed or altered if stolen.

Max Output Voltage (MaxOutVolt)

Displays the maximum output voltage per channel that can exist across the PLM's output terminals. This is the absolute maximum, not the voltage defined by the ISVPL setting.



When Bridge Mode is activated, double the channel output voltage is available.

Max Output Current (MaxOutCurr)

Displays the maximum output current that can be delivered by the PLM, summed across all output channels.

7.11.5.2 Frame Reset

MENU > FRAME > RESET

Use this option to display a further menu with options to reset all parameters back to their original factory default values. See section 9.3 for a full list of these values. Two types of reset are provided, Factory Reset and Soft Reset.

Factory Reset

A Factory Reset will reset all settings and parameters to the original factory-defined default values. This includes the deletion of any Frame Presets stored within the device. It also resets the IP Address and all network related settings; a hard power cycle is required to complete this reset.

Soft Reset

A Soft Reset will reset all settings and parameters to the original factory-defined default values, but retains Frame Preset information and IP / Network configuration. A power cycle is not required to complete this type of reset.

7.11.5.3 Breaker Emulation Limiter (PLM 20000Q ONLY)

MENU > FRAME > BEL CONF

The Breaker Emulation Limiter (BEL) provides Ampere selection (5-32 A) and breaker type selection (CONSERVATIVE, FAST and UNIVERSAL). Select by pressing the adjacent button then use the rotary encoder to change the parameter.

This option is only available on the PLM 20000Q.

7.11.5.4 Network

MENU > FRAME > NETWORK

Pressing the NETWORK button displays a further screen containing network configuration information. All parameters are view-only on the front panel and are either not editable, or can only be adjusted via the Lake Controller.

A summary at the top right of the screen confirms whether a valid connection is present for both Ethernet ports, and whether the Lake Controller is online.

- ▶ IP Addr: Displays the Internet Protocol address for the selected unit and can only be changed via the Lake Controller software. Please refer to the Lake Controller Operation Manual for further details.
- ▶ IP Mask: Displays the IP address subnet mask for the selected unit and can only be changed via the Lake Controller software. Please refer to the Lake Controller Operation Manual for further details.
- ▶ MAC: Displays the unique Media Access Control Ethernet address for the processor. This value cannot be changed.
- ▶ F.ID: Displays the Frame ID, a unique Lake product identifier that cannot be changed.

7.11.5.5 Latency Match

To turn Latency Match on or off, select the parameter using the adjacent button then change the status using the rotary encoder.

When Latency Match is ON the LM 26 adds delay to match the overall processing delay of legacy Lake Contour Pro 26 and Mesa Quad EQ products. Please refer to the Lake Controller Operation Manual for further information.

7.11.6 Front Panel Display Controls

MENU > FRAME > FRONT

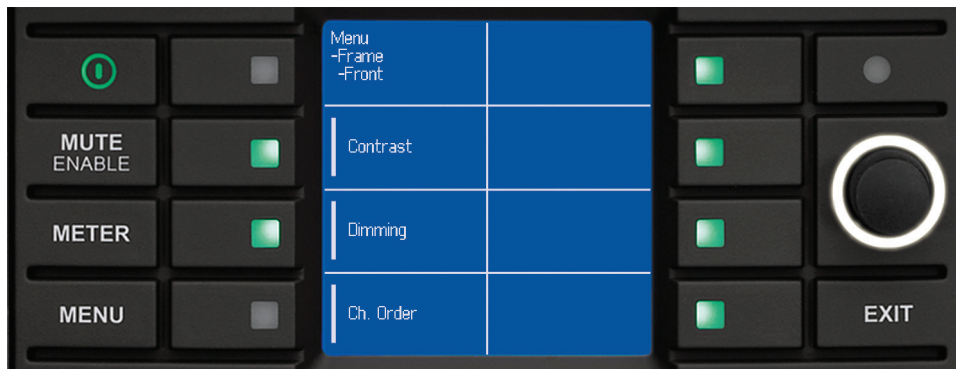

Figure 7-18: Front Panel Display Controls Menu

Contrast

To adjust the front panel LCD contrast, select this option then use the rotary encoder to change the value.

Dimming

To adjust the front panel LCD brightness, select this option then use the rotary encoder to change the value.

Channel Order

To adjust the order in which both inputs and outputs are displayed on the front panel in all views, select this option then use the rotary encoder to change the value between TOP-DOWN (default) and BOTTOM-UP.

7.11.7 Frame Preset Menu

MENU > FRAME PRST



Figure 7-19: Frame Preset Menu

To recall an existing Frame Preset, use the rotary encoder to select the required Preset then press the RECALL button to overwrite the current configuration.



Frame Presets must initially be created in the Lake Controller, and stored as a Preset using the Lake Controller or Lake Preset Manager.

Up to 100 Frame Presets can be stored in the device. The data within a Frame Preset includes the configuration of all Modules in the Frame including levels, crossovers, EQ, input mixer, and output routing.

As Frame Presets are stored within the device, complete processor configurations can be recalled without connecting the device to a PC.

7.11.8 Load Monitor Menu (LoadSmart)

MENU > LOAD MON

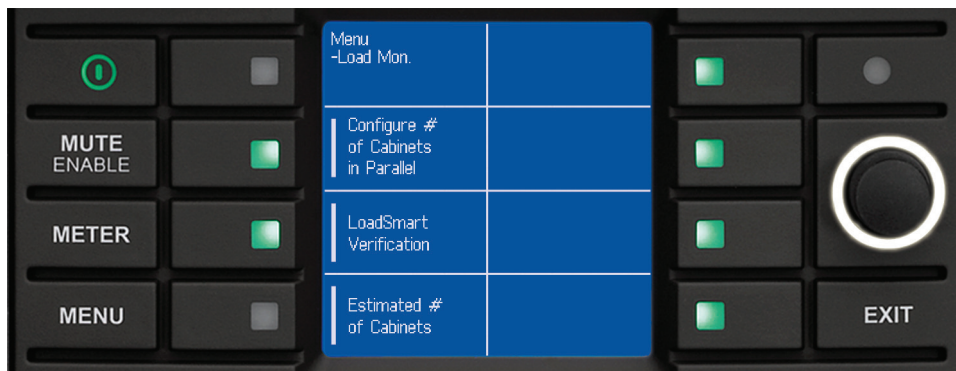

Figure 7-20: Load Monitor Menu

7.11.8.1 Configure # of Cabinets in Parallel

This option allows selection of the number of speaker cabinets connected to each PLM output channel. Select individual or multiple outputs and use the rotary encoder to set the value from 1 to 4. This value is used by LoadSmart and SpeakerSafe to confirm the correct connection and status of the speakers connected to each PLM channel.

7.11.8.2 LoadSmart Verification

Select this option to initiate LoadSmart verification, then select YES to continue. LoadSmart performs a rapid test of all output channels, and displays the results on the LCD a few seconds later.

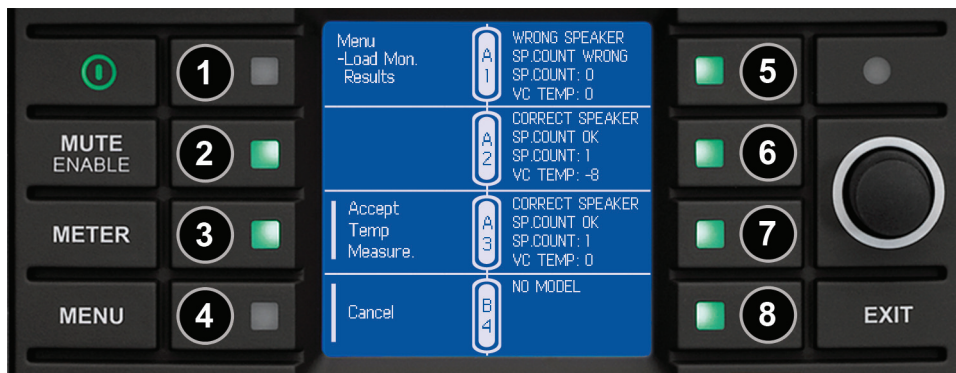

Figure 7-21: LoadSmart Verification Results Screen

The Load Results page provides four items of information per output channel:

- ▶ Confirmation of the speaker Fingerprint assigned to the channel.
If no Fingerprint is assigned, NO MODEL will be displayed.
- ▶ Result of speaker cabinet count; this will either be OK or WRONG.
- ▶ Estimated number of speakers connected to the channel.
- ▶ Computed voice coil temperature, calculated from manufacturer's data contained within the loud-speaker Fingerprint.

If the displayed range of voice coil temperatures is acceptable, press ACCEPT TEMP MEASURE button to start SpeakerSafe monitoring using these temperatures as starting values.

If the range of displayed voicecoil temperatures contains one or more anomalous results, the Lake Controller should be used to manually enter the starting temperature for SpeakerSafe. Please refer to the PLM Series chapter in the Lake Controller Operation Manual for further information.

Once started, SpeakerSafe monitors the load on each power output channel, and displays associated results in Meter Mode > Temperature View, and also on the Status and History tabs in the Lake Controller.

7.11.8.3 Estimated # of Cabinets

When SpeakerSafe is active, this submenu displays the estimated number of cabinets from SpeakerSafe's continuous load monitoring.

7.11.9 Dante

MENU > DANTE



Figure 7-22: Dante Menu

Pressing the DANTE button from the main menu will display this screen only if Dante has previously been enabled via the Lake Controller software.

Please refer to the Lake Controller Operation Manual for further details regarding Dante implementation.

8. Back Panel Interface

An overview of the back panel interface is provided in section 4.2. This chapter describes each cluster of connections as shown in Figure 8-1.

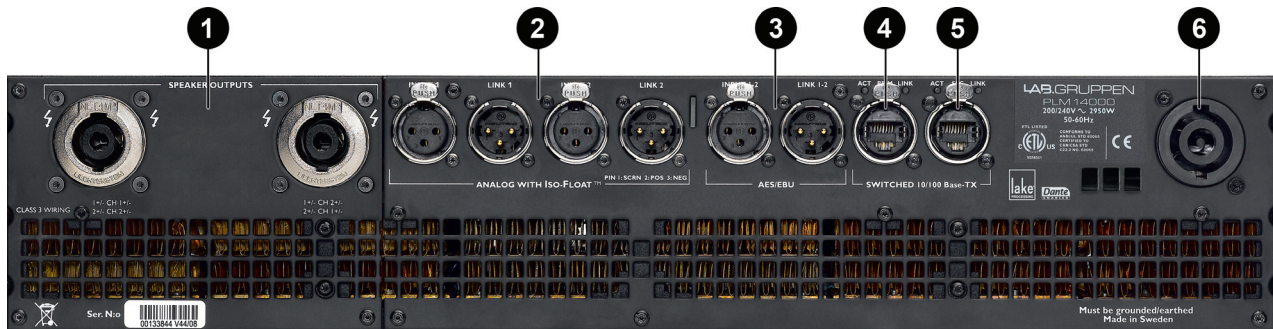

Figure 8-1: Back Panel Interface of a 2-channel PLM

8.1 Speaker Outputs

The PLM is available with either 4 mm binding posts or Neutrik speakON connectors for the outputs.

⚠ The outputs of the PLM can produce a high voltage. Do not connect or disconnect loudspeaker/s while the PLM is powered on. Never operate the PLM with any portion of bare loudspeaker wire exposed. For speakON connector versions, do not use mating plugs without the rear covers in place.

8.1.1 Bridge Mode

Power outputs may be bridged on all PLM models by following the configuration instructions in the Lake Controller Operation Manual (I/O CONFIG > OUTPUT CONFIGURATION) and the wiring instructions in this chapter. Bridge Mode can only be activated/deactivated using the Lake Controller software.



When Bridge Mode is activated, CLASS 3 wiring is required.

8.1.2 speakON Connectors ①

Figure 8-1 shows a 2-channel PLM 14000 with speakON connections. speakON connections are also available on the 4-channel PLM 10000Q and PLM 20000Q. Sections 8.1.2.1 and 8.1.2.2 describe the wiring, pin-out and output configuration for the 2- and 4-channel models respectively.

8.1.2.1 2-Channel PLM speakON Connections

2-channel models provide both power output channels simultaneously on two 4-pole speakON connectors. Both connectors carry both channels; the second connector offers the channels in reverse order.

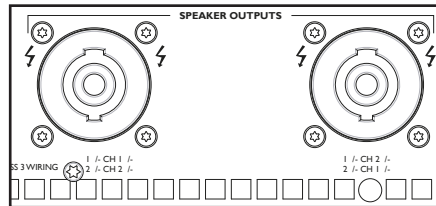

Figure 8-2: speakON Connections for 2-channel PLMs

Pin No.	NL4 #1 Ch. 1 & 2	NL4 #2 Ch. 2 & 1	NL4 #1 Ch. 1 & 2 (Bridge Mode)
1+	Ch. 1 o/p +	Ch. 2 o/p +	Ch. 1 o/p +
1-	Ch. 1 o/p -	Ch. 2 o/p -	
2+	Ch. 2 o/p +	Ch. 1 o/p +	
2-	Ch. 2 o/p -	Ch. 1 o/p -	Ch. 2 o/p -

Table 8-1: speakON Wiring and Pinouts for 2-channel PLMs (incl. Bridge Mode)

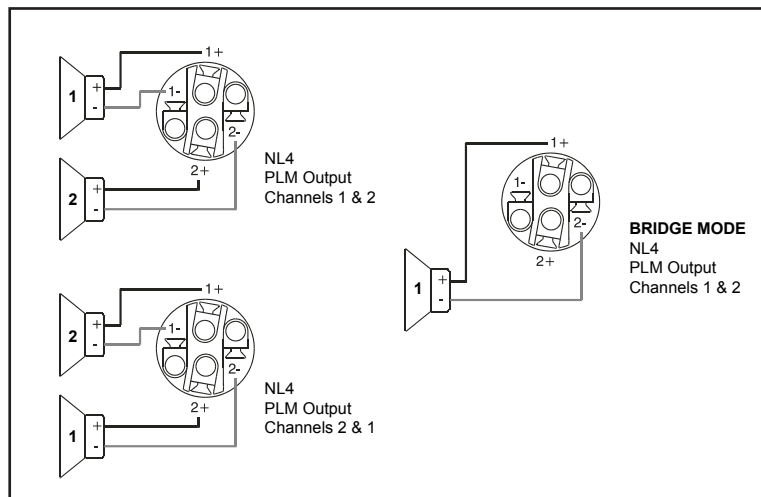

Figure 8-3: speakON NL4 Configurations for 2-channel PLMs (incl. Bridge Mode)

8.1.2.2 4-Channel PLM speakON Connections

On 4-channel models, the power outputs are simultaneously available on a single 8-pole speakON connector, and on two 4-pole speakON connectors. The two 4-pole connectors carry the outputs of channels 1 & 2 and 3 & 4 respectively.

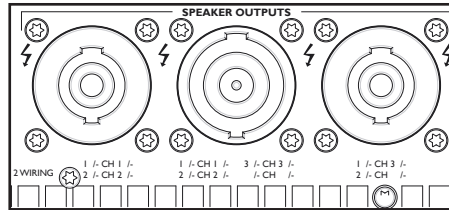

Figure 8-4: speakON Connections for 4-channel PLMs

Pin No.	NL4 #1 Ch. 1 & 2	NL8 Ch. 1 - 4	NL4 #2 Ch. 3 & 4
1+	Ch. 1 o/p +	Ch. 1 o/p +	Ch. 3 o/p +
1-	Ch. 1 o/p -	Ch. 1 o/p -	Ch. 3 o/p -
2+	Ch. 2 o/p +	Ch. 2 o/p +	Ch. 4 o/p +
2-	Ch. 2 o/p -	Ch. 2 o/p -	Ch. 4 o/p -
3+		Ch. 3 o/p +	
3-		Ch. 3 o/p -	
4+		Ch. 4 o/p +	
4-		Ch. 4 o/p -	

Table 8-2: speakON wiring and pinouts for 4-channel PLMs

Pin No.	NL4 #1 Ch. 1 & 2	NL8 Ch. 1 - 4	NL4 #2 Ch. 3 & 4
1+	Ch. 1 o/p +	Ch. 1 o/p +	Ch. 3 o/p +
1-			
2+			
2-	Ch. 2 o/p -	Ch. 2 o/p -	Ch. 4 o/p -
3+		Ch. 3 o/p +	
3-			
4+			
4-		Ch. 4 o/p -	

Table 8-3: speakON wiring and pinouts for 4-channel PLMs (Bridge Mode)

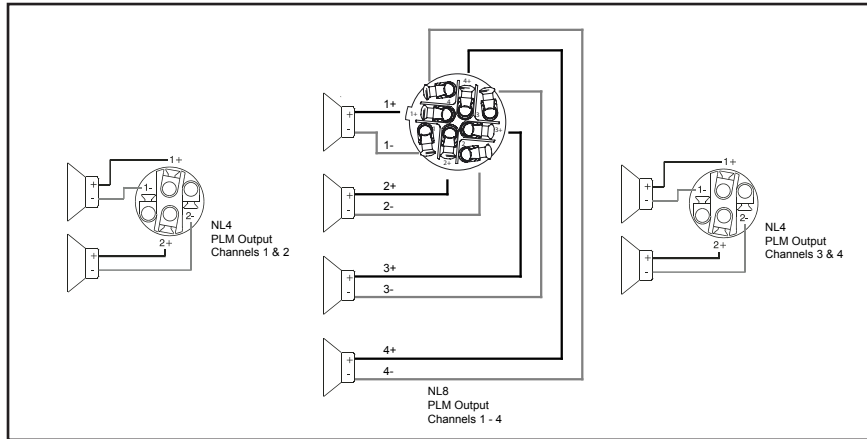

Figure 8-5: speakON NL4/NL8 Configuration for 4-channel PLMs

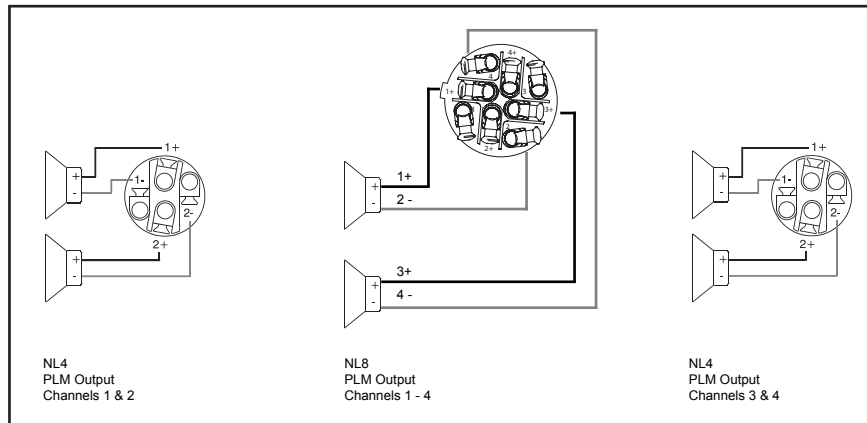

Figure 8-6: speakON NL4/NL8 Configuration for 4-channel PLMs (Bridge Mode)

8.1.3 Binding Post Connectors

Binding post versions of the PLM are fitted with four pairs of black and red 4 mm binding posts.

4-channel PLMs provide the output for one power output channel on each pair of binding posts as shown in Figure 8-7.

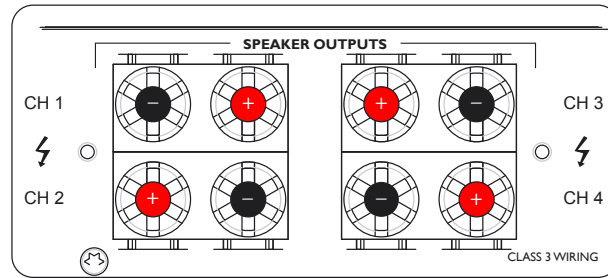

Figure 8-7: Binding Post Configuration for 4-channel PLM

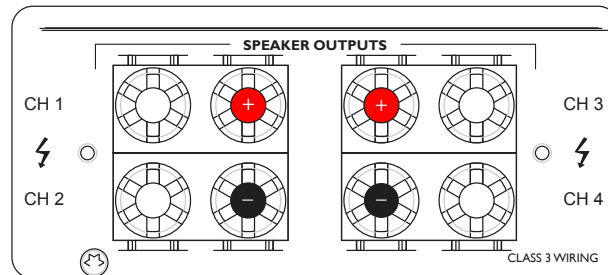

Figure 8-8: Binding Post Configuration for 4-channel PLM (Bridge Mode)

2-channel PLMs provide each power output channel from two pairs of binding posts as shown in Figure 8-9.

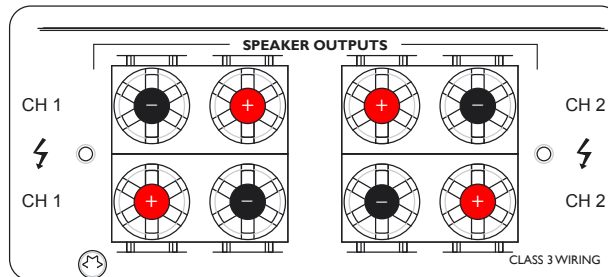

Figure 8-9: 2-channel PLM Binding Post Configuration

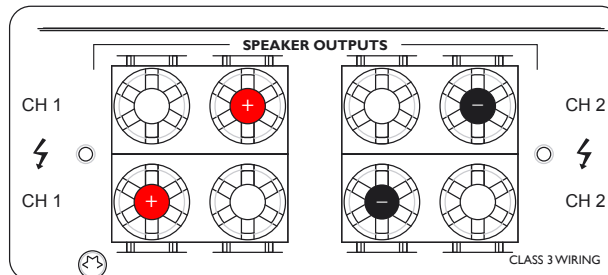

Figure 8-10: 2-channel PLM Binding Post Configuration (Bridge Mode)

Connect the '+' loudspeaker terminals to the red binding posts and the '-' terminals to the black binding posts. There are three methods of connecting speaker cables to the binding posts.

1. Solder 4 mm banana-plugs to the ends of the speaker wires and plug into the center of the turrets.
2. Thread the stripped ends of the wires through the holes in the posts. Enter the wires for output channels 1 and 3 from above and for channels 2 and 4 from below. Tighten the plastic turrets by finger only, being careful not to overtighten.
3. Crimp 4 mm insulated spade terminals onto the ends of the wires and push into the binding post assembly from above (Ch. 1 & 3) or below (Ch. 2 & 4). The hole in the post is ignored. Hand tighten plastic turrets, being careful not to overtighten.

8.2 Analog Inputs and Outputs

8.2.1 Analog Input and Link XLR Connections ②

Two electronically-balanced analog inputs are provided via latching XLR3F connections. The Link outputs on XLR3M connectors are directly paralleled to the inputs.

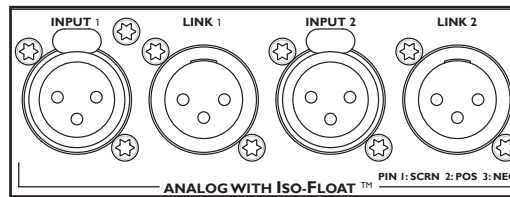

Figure 8-11: Analog Input and Link XLR Connections



When linking analog inputs of several PLMs, consider that the drive capability of the source's output stage (e.g. mixing console) may be limited. Generally it is inadvisable not to parallel link more than four inputs. If more links are required, use a good quality balanced audio line driver or distribution amplifier.

8.2.2 Analog & AES3 XLR Wiring and Pin Out

All XLR connections are wired to IEC268 as shown in Figure 8-12.

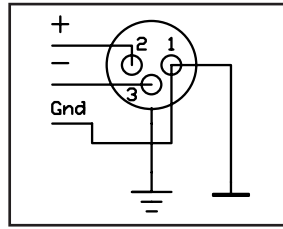

Figure 8-12: IEC268 XLR Wiring and Pin Out

- Pin 1: Ground / Shield
- Pin 2: Hot (+)
- Pin 3: Cold (-)

8.2.3 Unbalanced Operation

Balanced connections are recommended where possible. However, if it is necessary to drive the device from equipment with an unbalanced output, wire the inputs as shown in Figure 8-13.

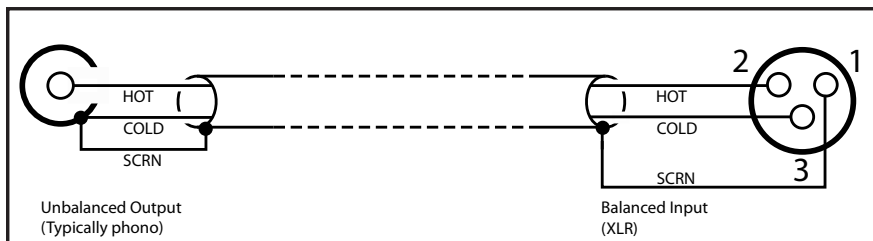

Figure 8-13: Balanced to Unbalanced Analog Wiring and Pin Out

The method shown in Figure 8-13 uses twin-and-screen (balanced) cable and standard XLR pin connections at the PLM end, with the cold wire and the cable screen connected to the signal ground of the equipment at the source end.

This usually provides better noise and hum rejection than the more common method of joining pins 1 and 3 together in the XLR. However, if only a single-core (unbalanced) cable is available, the method shown in Figure 8-14 may be used.

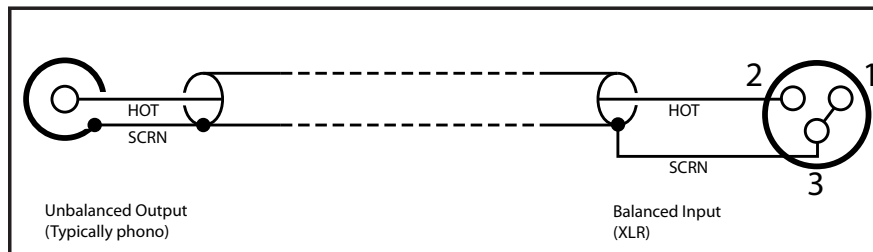

Figure 8-14: Unbalanced Analog Wiring and Pin Out

8.2.4 Iso-Float Electronic Balancing

The analog input electronic balancing circuits use the Lake Iso-Float system.

The Iso-Float technology combines the benefits of transformer-coupled isolation with the advantages of clean, direct-coupled inputs. The audio converters are galvanically isolated, and not connected to the main ground. High-quality transformers and opto-isolators create a barrier between the device and possible grounding aberrations from the outside electrical environment.

Iso-Float settings are adjustable via the front panel menu or the Lake Controller software.

8.3 AES3 Digital I/O

8.3.1 AES3 XLR Connector ③

AES3 digital audio input is via an XLR3F connector, which is directly paralleled to the adjacent XLR3M AES3 Link connector. Wiring of this connector follows the same standard as for analog XLR connections as shown section 8.2.2.

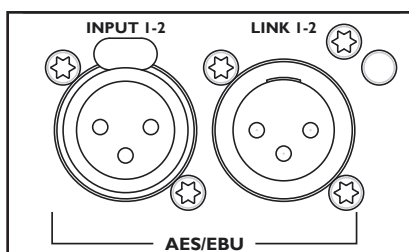

Figure 8-15: AES3 XLR Input and Link Connectors

Figure 8-12 on page 69 shows the only possible method of wiring; there is no equivalent of an unbalanced connection in the digital domain.

The AES3 signal format carries two channels of audio and associated data on a single cable/connector. Selection of Ch 1 or Ch 2 is performed within the digital processing section of the PLM and is controlled from the menu system. Please refer to section 7.11.3.1 for further details.

The AES3 Link connector may be used to daisy-chain the inputs of multiple PLMs together. Unlike daisy-chaining of analog inputs, attention must be paid to line termination. When daisy-chaining PLMs together, only the last PLM in the chain should be set to TERMINATED. All other PLMs should be set to UNTERMINATED. Please refer to section 7.11.3.2 for further details.

As with balanced analog audio, there is a finite limit to how many PLMs may have their AES3 inputs daisy-chained together. The practical limit will be determined by cable type and length as well as the output circuit of the driving source. It may be necessary to employ an AES3 line driver or distribution amplifier to achieve reliable results in some situations.



Tests indicate that up to 20 PLMs may have their AES3 inputs daisy-chained together, however circumstances and cabling used may reduce this figure. Please refer to section 10.6.

8.4 RJ45 etherCON Network Connections

Two RJ45 etherCON style network connections are provided as shown in Figure 8-16.

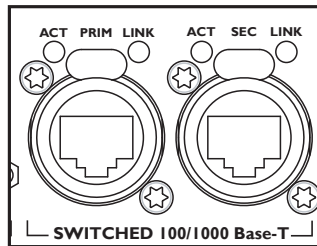

Figure 8-16: etherCON Network Connectors

The network connections auto-sense whether standard or crossover Cat-5e cables are in use. Pre-made cables with moulded RJ45 plugs are recommended. If it is necessary to make up custom Cat-5e network cables, use pinout described in Table 8-4.

Pin No.	Color
1	Brown
2	Brown + White
3	Green
4	Blue + White
5	Blue
6	Green + White
7	Orange
8	Orange + White

Table 8-4: RJ45 Wiring & Pin Out Description

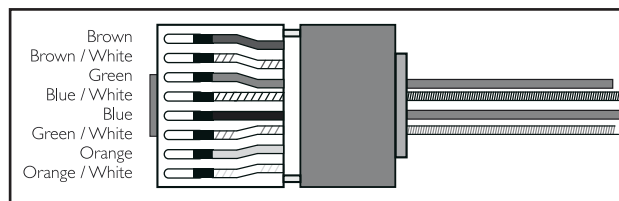

Figure 8-17: RJ45 Wiring and Pin Out Diagram

When the device is connected to an active network, the yellow LINK LED illuminates above the connector in use. Data activity on the network is indicated by illumination of the green ACT LED. It is normal for the ACT LED to flicker either sporadically or continuously.

8.4.1 Primary Network Connection ④

The Primary Network connection is used for Lake Controller connectivity and Dante digital audio. Please refer to section 4.2 for additional information.

8.4.2 Secondary Network Connection ⑤

The Secondary Network connection may be used for a redundant Dante digital audio network. Please refer to section 4.2 for additional information.

8.5 Power Inlet

8.5.1 Power Connector ⑦

A Neutrik NAC3 Series powerCON connector rated at 32 A is fitted to the rear of the PLM for AC mains input. The power cable (AC cord) supplied with the PLM has the mating connector ready-fitted, but may require a mains (AC) plug specific to your country to be fitted to the other end. The wiring and pinout details are shown in Table 8-5.

powerCON Pin	230 V Version	115 V Version
L	Brown	Black
N	Blue	White
	Green/Yellow	Green

Table 8-5: powerCON Connector Wiring and Pinout

9. Appendix

9.1 Faults and Warnings Overview

Fault or warning conditions are indicated by the LED shown in Figure 7-3 on page 34, and also by LEDs associated with the inputs and outputs on the PLM. As the LEDs indicate several types of faults or warnings, a brief textual description of the fault or warning is provided on the LCD display. Section 7.8.2 on page 34 details the fault and warning indications that appear on the front panel. Table 9-1 lists the events that may have triggered each fault or warning condition.

Model	Displayed Text	Event Log Text	Category	Description
ALL	AMP CH. MUTE	Amp Channel Mute	Mute	The audio signal has been muted in the power output stage.
ALL	ANALOG IN FAULT	Frame Fault: Analog Input	Fault	The analog input signal is corrupt due to DC on the analog input, or there is an issue with the internal A/D converter.
20000Q	ATL ACTIVE	N/A	Warning	The output power is limited due to high amplifier channel temperature - the amp channel temperature limiter is active.
ALL	AUDIO FAULT	Frame Fault: Audio Interface	Fault	An internal audio fault has arisen and the unit needs servicing.
20000Q	BEL ACTIVE	N/A	Warning	Breaker Emulation Limiter present as the nominal current reached. Improve the power distribution and adjust the BEL settings.
ALL	CAL ACTIVE	n/a	Fault	Ensures that the PLM's power output stages are not overloaded. This should never happen during normal program material.
20000Q	CHECK AC MAINS	Frame fault: Check AC Mains	Fault	The PSU received unstable mains, check the mains configuration.
ALL	CLOCK SLIPPING	AES Clock slipping	Warning	The AES or Dante clock is slipping; verify clock selection / generator. This will cause high THD on signal, and if Dante is running will result in an unstable signal distribution.
ALL	CTRL OFFLINE	N/A	Warning	The PLM is no longer able to communicate with the Lake Controller.
ALL	CURRENT CLIP	n/a	Clip	PLM's power output stage current has exceeded the fixed safe maximum and the Current Peak Limiter has become active to limit it.
ALL	INPUT CLIP	n/a	Clip	The input signal level is too high and is causing clipping at the input stage

Model	Displayed Text	Event Log Text	Category	Description
ALL	INPUT MUTE	Input Mute	Mute	The audio signal has been muted at the input router of the Lake Processor.
ALL	LM PREC. LOW	Speakersafe precision low	Warning	A SpeakerSafe warning indicating insufficient data to produce reliable results. This may occur, for example, if a channel is being driven at a very low level.
ALL	LOAD NOT VER	LoadSmart: Load Not Verified	Warning	A Module containing a Fingerprint has been loaded, but the load is yet to be verified with LoadSmart.
20000Q	MAINS <65 V	Frame fault: PSU mains <65 V	Fault	Mains input voltage is below 65 Volts RMS.
20000Q	MAINS >270 V	Frame fault: PSU mains >270 V	Fault	Mains input voltage is above 270 Volts RMS.
20000Q	MAINS >400 VPK	Frame fault: PSU mains >400 VPK	Fault	Mains input voltage is above 400 Volts Peak.
20000Q	MAINS GLITCH	Glitch on mains voltage detected	Warning	A glitch (missing cycles) on mains input was detected.
ALL	MOD. IN MUTE	Module Input Mute	Mute	The audio signal has been muted at the Module input of the Lake processor.
ALL	MOD. OUT MUTE	Module Output Mute	Mute	The audio signal has been muted in the output stage of the Lake processor.
ALL	MODULE CLIP	n/a	Clip	The signal level on the outputs of the Lake processing module is too high and is clipping.
ALL	n/a	LoadSmart Verification	Event	LoadSmart load verification is in progress.
ALL	n/a	Sound Source Changed	Event	The input router has changed sound source.
20000Q	NEED SERVICE:1	Frame fault: Need Service: 1	Fault	Service required, contact your dealer.
20000Q	NEED SERVICE:2	Frame fault: Need Service: 2	Fault	Service required, contact your dealer.
20000Q	NEED SERVICE:3	Frame fault: Need Service: 3	Fault	Service required, contact your dealer.
20000Q	NEED SERVICE:4	Frame fault: Need Service: 4	Fault	Service required, contact your dealer.
20000Q	NEED SERVICE:5	Frame fault: Need Service: 5	Fault	Service required, contact your dealer.
20000Q	NEED SERVICE:6	Frame fault: Need Service: 6	Fault	Service required, contact your dealer.
20000Q	NEED SERVICE:7	Frame fault: Need Service: 7	Fault	Service required, contact your dealer.
20000Q	NEED SERVICE:8	Frame fault: Need Service: 8	Fault	Service required, contact your dealer.
ALL	NO INPUT	No Input Source	Fault	The chosen input type has been deselected or lost and the input type selector has no alternative input sources in the priority list.
ALL	NO LOAD	Channel Fault: No Load Detected	Fault	No load detected at the power output channel.
ALL	OFFLINE	Frame Offline	Warning	The Lake Controller cannot communicate with this Lake device.

Model	Displayed Text	Event Log Text	Category	Description
ALL	OVER SPKR CNT	Over Speaker Count	Warning	A lower load impedance has been measured than was predicted by the Load Library for the assigned speaker type.
10000Q 14000	PAL ACTIVE	n/a	Fault	Total amplifier power being delivered has exceeded the safe maximum value and the PAL has become active.
20000Q	PAL ACTIVE	n/a	Warning	Output power is limited due to the PSU maximum current or power level has been reached and PAL has become active.
ALL	PSU FAULT	Frame Fault: PSU Undervoltage	Fault	The Power supply did not start up properly. It could be due to undervoltage on the mains or due to an internal non user-serviceable fault. If the mains are checked to be OK and the fault persists the unit should be returned to your dealer.
20000Q	PSU POWER PROT	Frame Fault: PSU Power Protect	Fault	Low input voltage, high power demand.
20000Q	PTL ACTIVE	N/A	Warning	The output power is limited due high temperature in the Power supply and the PSU Temperature Limiter is active
ALL	SENSE FAULT	Frame warning: Sense Fault	Warning	The output Voltage and Current sensors are lost. The PLM is OK for continued operation but is at risk of entering protective mutes states. Return device to dealer.
ALL	SERVICE CH.	Channel Fault: Unit Needs Service	Fault	One or more breakers in the power stage have blown. This is not a user-servicable fault; return device to dealer.
ALL	SHORT CIRCUIT	Channel Fault: Short Circuit Protection	Fault	The PLM is measuring both very high load current and very low output voltage. Short circuit protection is active.
ALL	SPKSAFE INACT	SpeakerSafe Not Started	Warning	Warns that after LoadSmart verification, SpeakerSafe monitoring was not started.
ALL	TEMP FLT:CH	Temp Fault: Amp Channel	Fault	Temperature in the power output stage exceeds safety limit.
ALL	TEMP FLT:DSP	Temp Fault: DSP Area	Fault	The temperature of the PLM's processing circuitry has exceeded its safety limit. Audio is not muted, but continued operation at this temperature is not recommended.
ALL	TEMP FLT:MAG	Temp Fault: Speaker Magnet	Fault	The temperature of the speaker magnet estimated by SpeakerSafe, has exceeded the manufacturers' recommended maximum.

Model	Displayed Text	Event Log Text	Category	Description
ALL	TEMP FLT:PSU	Temp Fault: Power Supply Unit	Fault	The temperature of the PLM's PSU has exceeded its safety limit.
ALL	TEMP FLT:VC	Temp Fault: Speaker Voice Coil	Fault	The temperature of the speaker voice coil (estimated by SpeakerSafe) has exceeded the manufacturers' recommended maximum.
ALL	TEMP WARN: PSU	Temp warning: Power Supply Unit	Warning	High temperature in the Power Supply Unit.
ALL	TEMP WARN:CH	Temp Warning: Amp Channel	Warning	High temperature in the power output stage.
ALL	TEMP WARN:MAG	Temp Warning: Speaker Magnet	Warning	The temperature of the speaker magnet is high (estimated by SpeakerSafe).
ALL	TEMP WARN:VC	Temp Warning: Speaker Voice-Coil	Warning	The temperature of the speaker voice coil is high (estimated by SpeakerSafe).
ALL	UNCERTAIN LOAD	Uncertain About Load Type	Warning	When speaker Fingerprints are taken a tolerance band is also defined to take into account production variations. If LoadSmart results lie in this band a Load uncertainty warning results. The user should re-check the load and if all appears to be correct it is likely that normal operation will result.
ALL	UNDER SPKR CNT	Under Speaker Count	Warning	A higher load impedance has been measured than was predicted by the Load Library for the assigned speaker type.
20000Q	UVL ACTIVE	N/A	Warning	The Under Voltage limiter is active as the mains supply has fallen between 65 and 80 Volts. Output power is decreased to ensure mains distribution does not sag.
ALL	VHF FAULT	Channel Fault: Very High Frequency	Fault	An exceptionally high level of continuous HF has been detected at the PLM's power output stage.
ALL	VOLTAGE CLIP	n/a	Fault	The peak voltage at the output terminals has exceeded the user-defined safe maximum.
ALL	WRONG LOAD	Load Type / Routing Mismatch	Fault	LoadSmart is measuring load characteristics which differ from those of the assigned speaker type.

Table 9-1: Warning, Fault and Mute Indications (alphabetical by LCD Text / Event Log Text)

9.2 Maintenance

During normal operation this device provides trouble-free service. If the LCD or front panel display requires cleaning, use a soft cloth only; do not use solvent cleaners. The dust filters on both sides of the front panel, behind the grilles, should occasionally be removed and cleaned to ensure maximum airflow through the device.



Disconnect the unit from mains power prior to removing dust the filter, and ensure the dust filter is replaced prior to turning the unit back on.



Do not use sharp or metal objects to remove the dust filter, and be careful that the implement used to remove the filter does not enter the device.

In extreme cases it may be necessary to clean the inside of the device. This procedure should only be carried out by qualified service personnel. This may be necessary if the device has had prolonged operation in an extreme environment such as one where cracked oil smoke machines are in use. If the device is used in extreme conditions, it is recommended to have it serviced every three years as a preventative measure.

9.3 Factory Default Settings

9.3.1 Module Defaults

Module Type:	2 x 2 Aux
Mod Input Mute:	On
Mod Output Mutes:	Off
Gain:	0 dB (unity)
Delay:	0 ms
Polarity:	Positive (In phase)
MaxRMS:	20 dB
MaxPeak:	21 dB
Amp Gain:	35 dB
ISVPL:	153 V [PLM 10000Q] 193 V [PLM 14000] 194 V [PLM 20000Q]
Input & Output EQ:	Flat

9.3.2 Input and Router Defaults

Autoselect:	On
Input sensitivity:	+26 dBu
Dante:	Disabled
AES3:	Terminated
Iso-Float:	Enabled
Router 1:	AES1 (Ch.1) as Priority 1, Analog 1 as Priority 4
Router 2:	AES1 (Ch.2) as Priority 1, Analog 2 as Priority 4

9.3.3 Amplifier Defaults

Attenuation:	0 dB
Polarity:	Positive (In phase)
Mutes:	Unmuted
Load Model:	No Load Model
Breaker Emulation Limiter:	32 A - Breaker Fast (PLM 20000Q only)

9.4 Current Draw and Thermal Dissipation Specifications

The tables in this section provide measured current consumption and calculated heat dissipation for five different operating conditions for each PLM Series device.

1. Standby Mode
2. Power On (Idle - No Signal)
3. Power On (Normal Operation - Pink Noise 1/8 of Rated Power)
4. Power On (Heavy Duty Operation - Pink Noise Max Power) - Not available for PLM 20000Q
5. Power On (Pilot Tone Operation - 20 kHz Sine Wave)

PLM 20000Q									
Level	Load	Rated power	Line current [A]	Power factor [%]	Measured Power [W]			Thermal Dissipation	
					In	Out	Dissipated	BTU/hr	kCal/hr
Mains voltage 100 VAC 30A									
Standby			0,4	50,6	18	0	18	61	15
Power On, Idling			2,3	95,4	223	0	223	763	192
Pink pseudo noise*1)	16 Ω / Ch.	1150 x 4	12,5	98,9	1237	575	662	2260	569
	8 Ω / Ch.	2350 x 4	22,6	99,0	2237	1175	1062	3623	913
	4 Ω / Ch.	4400 x 4	30,0	99,0	2970	1487	1483	5060	1275
	2,67 Ω / Ch.	5000 x 4	30,0	99,0	2970	1431	1539	5252	1323
	2 Ω / Ch.	4800 x 4	30,0	99,0	2970	1335	1635	5579	1406
Mains voltage 120 VAC 30A									
Standby			0,3	47,1	18	0	18	61	15
Power On, Idling			2,0	94,9	223	0	223	763	192
Pink pseudo noise*1)	16 Ω / Ch.	1150 x 4	10,1	98,7	1193	575	618	2109	531
	8 Ω / Ch.	2350 x 4	18,1	99,0	2156	1175	981	3349	844
	4 Ω / Ch.	4400 x 4	30,0	99,0	3564	1926	1638	5591	1408
	2,67 Ω / Ch.	5000 x 4	30,0	99,0	3564	1816	1748	5967	1503
	2 Ω / Ch.	4800 x 4	30,0	99,0	3564	1687	1877	6406	1614
Mains voltage 208 VAC 17,3 A									
Standby			0,3	28,7	18	0	18	61	15
Power On, Idling			1,2	88,1	223	0	223	763	192
Pink pseudo noise*1)	16 Ω / Ch.	1150 x 4	6,7	98,5	1372	575	797	2720	685
	8 Ω / Ch.	2350 x 4	10,6	99,0	2192	1175	1017	3472	875
	4 Ω / Ch.	4400 x 4	17,3	99,0	3562	1895	1668	5692	1434
	2,67 Ω / Ch.	5000 x 4	17,3	99,0	3562	1764	1798	6138	1546
	2 Ω / Ch.	4800 x 4	17,3	99,0	3562	1691	1871	6386	1609
Mains voltage 230 VAC 16 A									
Standby			0,3	25,1	18	0	18	61	15
Power On, Idling			1,1	87,9	223	0	223	763	192
Pink pseudo noise*1)	16 Ω / Ch.	1150 x 4	5,2	98,2	1183	575	608	2076	523
	8 Ω / Ch.	2350 x 4	9,1	99,0	2078	1175	903	3083	777
	4 Ω / Ch.	4400 x 4	16,0	99,0	3643	2093	1550	5291	1333
	2,67 Ω / Ch.	5000 x 4	16,0	99,0	3643	2073	1570	5359	1350
	2 Ω / Ch.	4800 x 4	16,0	99,0	3643	1904	1739	5934	1495
Mains voltage 230 VAC 16 A									
Standby			0,3	25,1	18	0	18	61	15
Power On, Idling			1,1	87,9	223	0	223	763	192
Pink pseudo noise*1)	16 Ω / Ch.	1150 x 4	5,2	98,2	1183	575	608	2076	523
	8 Ω / Ch.	2350 x 4	9,1	99,0	2078	1175	903	3083	777
	4 Ω / Ch.	4400 x 4	16,0	99,0	3643	2093	1550	5291	1333
	2,67 Ω / Ch.	5000 x 4	16,0	99,0	3643	2073	1570	5359	1350
	2 Ω / Ch.	4800 x 4	16,0	99,0	3643	1904	1739	5934	1495
Mains voltage 230 VAC 16 A									
Standby			0,3	25,1	18	0	18	61	15
Power On, Idling			1,1	87,9	223	0	223	763	192
Mains voltage 230 VAC 16 A									
Standby			0,3	25,1	18	0	18	61	15
Power On, Idling			1,1	87,9	223	0	223	763	192
Mains voltage 230 VAC 16 A									
Standby			0,3	25,1	18	0	18	61	15
Power On, Idling			1,1	87,9	223	0	223	763	192
Mains voltage 230 VAC 16 A									
Standby			0,3	25,1	18	0	18	61	15
Power On, Idling			1,1	87,9	223	0	223	763	192
Mains voltage 230 VAC 16 A									
Standby			0,3	25,1	18	0	18	61	15
Power On, Idling			1,1	87,9	223	0	223	763	192
Mains voltage 230 VAC 16 A									
Standby			0,3	25,1	18	0	18	61	15
Power On, Idling			1,1	87,9	223	0	223	763	192
Mains voltage 230 VAC 16 A									
Standby			0,3	25,1	18	0	18	61	15
Power On, Idling			1,1	87,9	223	0	223	763	192
Mains voltage 230 VAC 16 A									
Standby			0,3	25,1	18	0	18	61	15
Power On, Idling			1,1	87,9	223	0	223	763	192
Mains voltage 230 VAC 16 A									
Standby			0,3	25,1	18	0	18	61	15
Power On, Idling			1,1	87,9	223	0	223	763	192
Mains voltage 230 VAC 16 A									
Standby			0,3	25,1	18	0	18	61	15
Power On, Idling			1,1	87,9	223	0	223	763	192
Mains voltage 230 VAC 16 A									
Standby			0,3	25,1	18	0	18	61	15
Power On, Idling			1,1	87,9	223	0	223	763	192
Mains voltage 230 VAC 16 A									
Standby			0,3	25,1	18	0	18	61	15
Power On, Idling			1,1	87,9	223	0	223	763	192
Mains voltage 230 VAC 16 A									
Standby			0,3	25,1	18	0	18	61	15
Power On, Idling			1,1	87,9	223	0	223	763	192
Mains voltage 230 VAC 16 A									
Standby			0,3	25,1	18	0	18	61	15
Power On, Idling			1,1	87,9	223	0	223	763	192
Mains voltage 230 VAC 16 A									
Standby			0,3	25,1	18	0	18	61	15
Power On, Idling			1,1	87,9	223	0	223	763	192
Mains voltage 230 VAC 16 A									
Standby			0,3	25,1	18	0	18	61	15
Power On, Idling			1,1	87,9	223	0	223	763	192
Mains voltage 230 VAC 16 A									
Standby			0,3	25,1	18	0	18	61	15
Power On, Idling			1,1	87,9	223	0	223	763	192
Mains voltage 230 VAC 16 A									
Standby			0,3	25,1	18	0	18	61	15
Power On, Idling			1,1	87,9	223	0	223	763	192
Mains voltage 230 VAC 16 A									
Standby			0,3	25,1	18	0	18	61	15
Power On, Idling			1,1	87,9	223	0	223	763	192
Mains voltage 230 VAC 16 A									
Standby			0,3	25,1	18	0	18	61	15
Power On, Idling			1,1	87,9	223	0	223	763	192
Mains voltage 230 VAC 16 A									
Standby			0,3	25,1	18	0	18	61	15
Power On, Idling			1,1	87,9	223	0	223	763	192
Mains voltage 230 VAC 16 A									
Standby			0,3	25,1	18	0	18	61	15
Power On, Idling			1,1	87,9	223	0	223	763	192
Mains voltage 230 VAC 16 A									
Standby			0,3	25,1	18	0	18	61	15
Power On, Idling			1,1	87,9	223	0	223	763	192
Mains voltage 230 VAC 16 A									
Standby			0,3	25,1	18	0	18	61	15
Power On, Idling			1,1	87,9	223	0	223	763	192
Mains voltage 230 VAC 16 A									
Standby			0,3	25,1	18	0	18	61	15
Power On, Idling			1,1	87,9	223	0	223	763	192
Mains voltage 230 VAC 16 A									
Standby			0,3	25,1	18	0	18	61	15
Power On, Idling			1,1	87,9	223	0	223	763	192
Mains voltage 230 VAC 16 A									
Standby			0,3	25,1	18	0	18	61	15
Power On, Idling			1,1	87,9	223	0	223	763	192
Mains voltage 230 VAC 16 A									
Standby			0,3	25,1	18	0	18	61	15
Power On, Idling			1,1	87,9	223	0	223	763	192
Mains voltage 230 VAC 16 A									
Standby			0,3	25,1	18	0	18	61	15
Power On, Idling			1,1	87,9	223	0	223	763	192
Mains voltage 230 VAC 16 A									
Standby			0,3	25,1	18	0	18	61	15
Power On, Idling			1,1	87,9	223	0	223	763	192
Mains voltage 230 VAC 16 A									
Standby			0,3	25,1	18	0	18	61	15
Power On, Idling			1,1	87,9	223	0	223	763	192
Mains voltage 230 VAC 16 A									
Standby			0,3	25,1	18	0	18	61	15
Power On, Idling			1,1	87,9	223	0	223	763	192
Mains voltage 230 VAC 16 A									
Standby			0,3	25,1	18	0	18	61	15
Power On, Idling			1,1	87,9	223	0	223	763	192
Mains voltage 230 VAC 16 A									
Standby			0,3	25,1	18	0	18	61	15
Power On, Idling			1,1	87,9	223	0	223	763	192
Mains voltage 230 VAC 16 A									
Standby			0,3	25,1	18	0	18	61	15
Power On, Idling			1,1	87,9	223	0	223	763	192
Mains voltage 230 VAC 16 A									
Standby			0,3	25,1	18	0	18	61	15
Power On, Idling			1,1	87,9	223	0	223	763	192
Mains voltage 230 VAC 16 A									
Standby			0,3	25,1	18	0	18	61	15
Power On, Idling			1,1	87,9	223	0	223	763	192
Mains voltage 230 VAC 16 A									
Standby			0,3	25,1	18	0	18	61	15
Power On, Idling			1,1	87,9	223	0	223	763	192
Mains voltage 230 VAC 16 A									
Standby			0,3	25,1	18	0	18	61	15
Power On, Idling			1,1	87,9	223	0	223	763	192
Mains voltage 230 VAC 16 A									
Standby			0,3	25,1	18	0	18	61	15
Power On, Idling			1,1	87,9	223	0	223	763	192
Mains voltage 230 VAC 16 A									
Standby			0,3	25,1	18	0	18	61	15
Power On, Idling			1,1	87,9	223	0	223	763	192
Mains voltage 230 VAC 16 A</									

PLM 14000									
Level	Load	Rated power	Line Current *2)		Watt *1)			Thermal Dissipation	
			120 VAC	230 VAC	In	Out	Dissipated	BTU/hr	kCal/hr
Standby					12	0	12	42	11
Powered on, idling.					116	0	116	395	100
			Amp (I)		Watt				
Pink noise (1/8 rated power)	16 Ω / Ch.	1150 x 2	8.5	4.4	603	288	315	1077	271
	8 Ω / Ch.	2300 x 2	13.7	7.2	1023	575	448	1529	385
	4 Ω / Ch.	4400 x 2	23.4	12.2	1838	1100	738	2518	634
	2.67 Ω / Ch.	6200 x 2	30.0	15.7	2410	1550	860	2935	739
	<i>2 Ω / Ch.*4)</i>	<i>7000 x 2</i>	<i>34.0</i>	<i>17.8</i>	<i>2767</i>	<i>1750</i>	<i>1017</i>	<i>3471</i>	<i>874</i>
Pink noise (max power) *3)	16 Ω / Ch.	1150 x 2	14.1	7.4	1040	575	465	1588	400
	8 Ω / Ch.	2300 x 2	23.7	12.4	1834	1150	684	2334	588
	4 Ω / Ch.	4400 x 2	30.0	16.0	2448/2502	1569/1606	879/897	2999/3060	756/771
	2.67 Ω / Ch.	6200 x 2	30.0	16.0	2544/2601	1593/1630	951/971	3247/3313	818/835
	2 Ω / Ch.	7000 x 2	30.0	16.0	2623/2682	1626/1664	997/1017	3403/3473	857/875
20 kHz Surveillance tone	16 Ω / Ch.	1 x 2	2.3	1.2	119	2	117	400	101
Mains connector - 230 V CE version / 230 V ETL version / 115 V ETL version						32 A, Neutrik® PowerCon® Twist lock			
*1) The amplifier section's PSU operates as a non-resistive load, so the calculation "Volts x Amps = Watts" would not be correct. Instead, measured and specified here is what is known as the "Active Power" of the amplifier section providing useful, real-world values of power consumption and heat dissipation.									
*2) Current draw figures measured at 230 V. 115 V figures are converted from 230 V figures.									
*3) Figures measured at maximum sustainable power without tripping the mains breaker. Listed separately for 30 A/115 V and 16 A/230 V operation. Note that the max. power condition is very extreme and will not occur during normal operation. Also note that the mains breaker will not be tripped even if operation is momentarily in excess of max. ratings.									
*4) <i>Italics used for conditions that, if sustained over long time periods, may trigger the mains breaker. Therefore these measurements should not be used when calculating cooling requirements as they cannot be sustained by the mains breaker over time.</i>									

Table 9-3: PLM 14000 Current Draw and Thermal Dissipation

PLM 10000Q									
Level	Load	Rated power	Line Current *2)		Watt *1)			Thermal Dissipation	
			120 VAC	230 VAC	In	Out	Dissipated	BTU/hr	kCal/hr
Standby					4.8	0	4.8	16	4
Powered on, idling.					145	0	145	496	125
			Amp (I)		Watt				
Pink noise (1/8 rated power)	16 Ω / Ch.	660 x 4	9.3	4.8	687	330	357	1218	307
	8 Ω / Ch.	1300 x 4	16.3	8.5	1250	650	600	2048	516
	4 Ω / Ch.	2300 x 4	25.2	13.2	2014	1150	864	2949	743
	2.67 Ω / Ch.	2700 x 4	31.3	16.4	2553	1350	1203	4106	1034
	2 Ω / Ch.	2350 x 4	29.2	15.2	2341	1175	1166	3980	1003
Pink noise (max power) *3)	16 Ω / Ch.	660 x 4	14.7	7.7	1098	660	438	1495	377
	8 Ω / Ch.	1300 x 4	26.0	13.6	2049	1300	749	2556	644
	4 Ω / Ch.	2300 x 4	45.8	23.9	3746	2300	1446	4935	1243
	2.67 Ω / Ch.	2700 x 4	52.5	27.4	4420	2700	1720	5870	1479
	2 Ω / Ch.	2350 x 4	51.0	26.6	4179	2350	1829	6242	1573
20 kHz Surveillance tone	16 Ω / Ch.	1 x 4	2.7	1.4	160	4	156	532	134
	16 Ω / Ch.	0.25 x 4	2.5	1.3	149	1	148	505	127
Mains connector - 230 V CE version / 230 V ETL version / 115 V ETL version						32 A, Neutrik® PowerCon® Twist lock			
<p>*1) The power output section's PSU operates as a non-resistive load, so the calculation "Volts x Amps = Watts" would not be correct. Instead, measured and specified here is what is known as the "Active Power" of the power output section providing useful, real-world values of power consumption and heat dissipation.</p> <p>*2) Current draw figures measured at 230 V. 115 V figures are converted from 230 V figures.</p> <p>*3) Figures measured at maximum sustainable power without tripping the mains breaker. Listed separately for 30 A/115 V and 16 A/230 V operation. Note that the max. power condition is very extreme and will not occur during normal operation. Also note that the mains breaker will not be tripped even if operation is momentarily in excess of max. ratings.</p>									

Table 9-4: PLM 10000Q Current Draw & Thermal Dissipation

9.5 Glossary of Terms, Acronyms and Abbreviations

The explanations given in Table 9-5 below are based on the specific use of each term in this manual. The definitions are not intended to be exhaustive and many of these terms have wider meanings.

Term	Description
100/1000 Base-T	100/1000 Base-T is IT industry-speak for different standards of Ethernet network. This term incorporates 100 Base-TX, which operates at 100 Mbps, and 1000 Base-T which operates at 1000 Mbps (1 Gbps).
Access Point	See Wireless Access Point.
Auto-Sensing	The Ethernet ports automatically determine the base speed of the network they are connected to (10 Base-T or 100 Base-T) and configure themselves appropriately. This is termed auto-sensing.
Auto-Uplink	The Ethernet ports can operate with either straight or crossed network cables; the ability to connect correctly with either type is termed auto-uplinking.
Auxiliary Output	Some of the configurations possible in the Lake processing system Modules result in a single audio processing channel being created in addition to a crossover. This is termed an Auxiliary output.
Backbone	Large Ethernet networks are often implemented with a very high speed "trunk" part of the network topology feeding main switches, which in turn support smaller, lower-speed local networks. The term backbone is used to describe such a trunk.
Bandwidth	The bandwidth of a signal channel or interconnection is the range of frequencies it is able to handle. The term can be applied to both audio channels and Ethernet networks.
BEL	Available on PLM 20000Q devices only, the Breaker Emulation Limiter (BEL) provides functionality to emulate a breaker, with user adjustable characteristics.
Breaker	A breaker (in relation to BEL configuration) is a virtual fuse providing three breaker emulation settings (Conservative, Fast & Universal).
Cat-5e/Cat-6, etc.	Designations of industry-standard cables suitable for Ethernet networks using four twisted pairs of conductors. Often referred to as UTP cable (Unscreened Twisted Pair). Cat-5 has generally been replaced by Cat-5e (e = 'enhanced'). Either Cat-5e or Cat-6 cable are suitable for networking Lake and Lab.gruppen devices.
Chain	An Ethernet network comprising several devices interconnected using the Secondary connectors to daisy-chain the units together is an example of a network with a chain topology.
Clock	Digital audio is produced by sampling analog audio at a known, fixed rate, controlled by some form of master clock. Problems can occur when interconnecting two pieces of digital audio equipment if their internal master clocks are not synchronized. Various techniques may be employed to ensure that this is the case.
CPL	An abbreviation for Current Peak Limiter, a Lab.gruppen protection technique which ensures that the amplifier's output transistors can never attempt to deliver more than their rated current.
Crossed Network Cable	An Ethernet cable in which four of the eight conductors (pins 1, 2, 5 & 6) are not wired pin-to-pin. Such a cable is required in conventional IT networks to connect two PCs together without using a hub or switch. The auto-uplink feature of the Ethernet ports allows crossed cables to be used if wished. See also Straight network cable.
Dante	A new-generation audio data protocol developed by Audinate® Pty Ltd, allowing multichannel high-resolution digital audio plus control data to be transmitted via standard IT-industry networks using TCP/IP data packets. The Lake processing system integrated within the PLM includes a dual-redundant Dante network interface, providing digital audio inputs and outputs via Ethernet.
dBu	dBu's are usually used instead of voltages to describe signal levels in audio systems. A signal level of 0 dBu may be taken as 0,775 Vrms.
Delay	Up to two seconds of delay may be added to the input and/or output channels to time-align loudspeaker arrays.
Digital Gain Offset	Digital gain offset is effectively a 'fine' gain adjustment performed in the digital domain, which can be applied to digital input signals to optimize the signal to the gain structure.
Distribution Amplifier	A distribution amplifier (usually abbreviated to DA) is an audio buffer stage – usually with zero gain – with one input and several outputs. Mono, stereo and AES3 digital versions can be obtained. Use of a DA to feed a signal to several destinations ensures correct impedance matching and isolation between source and destinations.
Dual-Network Topology	A network topology consisting of two (usually) identical networks, one connecting to the Primary Ethernet ports and the other to the Secondary ports. Although more complex to implement, the advantage of using a dual-network system is one of greatly improved reliability as one complete network remains operational if the other should fail.
Dynamic Function Buttons	The eight buttons around the front panel display are termed dynamic function buttons because their function varies depending upon which display page is currently on-screen.
Electronic Balancing	In the analog domain, balanced inputs and outputs may be provided on audio equipment either by the use of transformers or via electronic balancing circuits.
Event Log	The details of any fault or warning conditions which arise in the device during operation are recorded in a data file created by the Lake Controller software called the Event Log.
Fault	A Fault in the device occurs when one of the operating parameters exceeds pre-determined safety levels, or when a condition is detected that otherwise seriously affects the performance. Some fault conditions may result in one or all of the channels being muted.
Fingerprint	The Lake Controller comes includes a LoadLibrary consisting of data describing the electrical characteristics of commonly-used loudspeakers. The file for each speaker type is termed its Fingerprint.
FIR Filter	Finite Impulse Response Filter. An alternative design of crossover filter realisable in the digital domain, providing linear phase characteristics. FIR filtering is provided in all Lake devices.

Term	Description
Floating	An analog balanced input or output is said to be floating when full electrical isolation exists between that input or output and the equipment connected to it. Transformer-coupled inputs and outputs are inherently floating. Electronically balanced inputs and outputs can never be truly floating, though better designs – such as that found in the PLM - do mimic the characteristics of transformer-coupled designs to a high degree.
Frame	Lake terminology for a physical unit containing a Lake processing system, i.e. a single LM 26, PLM or legacy Lake Processor.
Frame ID	An electronic identification 'label' which can be given to each Frame in an amplification system. Naming Frames in a large system is desirable as it simplifies identification in the Lake Controller.
Frame Preset	Frame Presets are a class of Presets within the Lake processing system. Up to 100 can be stored in the hardware device, and each holds the complete configuration of all Modules and the Modules' internal settings.
Gigabit Ethernet	Describes the speed of Ethernet data transfer for devices that transmit Ethernet frames at a rate of a gigabit per second, as defined by the IEEE 802.3-2008 standard.
Hub	A type of network interface device with multiple Ethernet ports. Data arriving at any port is sent to all others. Hubs have been largely replaced by Switches.
In-Rush Current	When power is applied to a piece of electronic equipment, the initial current taken by the PSU can be very high as the various capacitors in the circuitry charge up; this is called the in-rush current. In the case of power amplifiers, which contain numerous very large capacitors, the in-rush current can be enough to blow mains breakers. The PLM's PSU contains circuitry to control the in-rush current to prevent this.
Input Level	The amplitude of an audio signal at the point where it is applied to the input of the device, or at the input of an intermediate stage within it. An analog input signal level will be expressed in dBu's, while a digital input signal level in dBFS (dBs below digital clip level; fS = full-scale)
IP Address	Every item of equipment connected to an Ethernet network has a unique address called the IP address, so that data gets to the correct place. IP addresses are written as four groups of three decimal numbers between 0 and 255. In a system consisting of Lake Processors and a Lake Controller they are assigned and detected automatically.
IP Subnet Mask	IP subnet masks are required in all IP networks. The subnet is determined by the size and type of network being used. For small networks (less than 254 addresses) a subnet mask of 255.255.255.0 can be used. (A Class C network).
Iso-Float	Iso-Float is Lake's proprietary method of electronic balancing, which provides a particularly high level of isolation and immunity from ground loops.
ISVPL	ISVPL is an abbreviation for Inter-Sample Voltage Peak Limiter, a proprietary Lab.gruppen technique for ensuring that voltage at the output terminals of a PLM does not exceed a pre-determined level. Eight ISVPL profiles provide the ability to configure for low distortion or high SPL specific to certain frequency ranges, or for universal use.
Lake Controller	The Lake Controller is the software application used to control LM 26 Processors, PLM Series and other Lake devices. This software application provides additional functionality and allows various grouping functions for simultaneous control of multiple Lake Processing-enabled devices.
Latency	The small but finite delay incurred by audio signals when they are transformed into the digital domain, processed digitally and then converted back into analog signals. In the Lake system, latency is assured to be constant.
Legacy Lake Device	This term refers to older Lake audio equipment which may form part of an audio system (i.e. Lake Contour Pro 26, Lake Mesa Quad EQ and the Dolby Lake Processor). The Lake Controller has the capability to control all Lake legacy products.
LimiterMax	LimiterMax is the name given to Lake's proprietary package of dynamics control which forms part of the Lake Processing system.
Line Driver	An analog audio amplifier, usually with zero gain, having very low output impedance and high drive capability. They are used for transmitting balanced analog audio over very long cables.
Linear Phase Crossover	See FIR Filters.
Load Library	The Lake Controller includes LoadLibrary, a set of Module files specific to the PLM Series. These Modules include a database of the electrical characteristics of various popular loudspeakers in addition to the standard Module data. The PLM uses the load data when verifying and monitoring amplifier loads. See Fingerprint, LoadSmart and SpeakerSafe.
Load, equal/unequal	The PLM draws different current levels from the AC supply, and thus has different power ratings according to whether all channels of the amplifier are driving into the same load impedance, or if there are different impedances on different channels.
LoadSmart	LoadSmart is a load verification procedure within the PLM which allows the operator to confirm that each PLM output has the correct quantity and type of speaker connected to it. It is intended to be used pre-performance prior to running SpeakerSafe.
Loop-Thru	This term refers to the Link connectors provided on the PLM for daisy-chaining further amplifiers or other equipment. The use of these to connect further devices is termed a loop-thru.
MAC Address	In addition to an IP address, every device on an Ethernet network has a MAC address. This address is fixed at the time of manufacture, and is effectively the permanent identifier of the physical unit. MAC stands for Media Access Control
MaxPeak	Lake's LimiterMax provides independent dynamics control over signal peaks (MaxPeak) and the average signal level (MaxRMS).
MaxRMS	See MaxPeak.
Module	Module is the term used in the Lake Controller to describe the virtual set of signal processing that routes an audio input to the various frequency-weighted outputs of a crossover. The processing system within the device allows for two Modules, each of which may be assigned a range of crossover configurations, input sources, etc.
Module Preset	A class of Preset within the Lake processing system. A Module Preset (Module file) contains all the configuration data and settings for one Module, and is saved in the Lake Controller software, not in the hardware device.
Offline	A device on an Ethernet network which is not communicating with the rest of the network either due to a fault or intentionally is said to be offline.
Online	A device on an Ethernet network which is fully operational and communicating with the rest of the network is said to be online.

Term	Description
PAL	An abbreviation for Power Average Limiter, PAL is proprietary Lab.gruppen circuit which provides additional amplifier protection. The PAL ensures that the power drawn by the PSU from the AC mains does not exceed the mains breaker ratings.
Parallel	Two or more e.g. inputs which are wired together so that all inputs are connected to the same source are said to be paralleled. Signal levels will be reduced if too many inputs are paralleled; in the case of AES3, this may result in a complete loss of audio.
Parameter	Any control function which can be adjusted by the user to one of several different values is termed a parameter. For example, input level, gain, delay, and limiter threshold are all parameters.
Pass-Through Cable	See Straight network cable.
PFC	Power Factor Correction. PFC reduces current peaks on the lines and reduces the requirements placed on the mains distribution system.
Ping	Ping is a term coined by the IT industry to the procedure of sending a command over a network to a particular Ethernet device asking it to confirm its identity and possibly reply with additional information. Thus an Lake device on the network can be pinged from the Lake Controller; on receipt of the 'ping', the hi-intensity white LED on the front panel illuminates. Reverse pinging is also possible, whereby the ping is instigated from Lake hardware device and a visual identification of the processor registers in the Lake Controller software.
Preset	A complete frame configuration that is stored in the device hardware.
Primary Ethernet Port	The Primary Ethernet port on the is the means of connecting the device to a network. See also Secondary Ethernet Port.
PSU	Abbreviation of Power Supply Unit. The PSU in any item of electronic equipment converts the AC mains into a set of internal DC voltages which run the electronic assemblies themselves.
RJ45	RJ45 connections are the industry-standard connectors for Ethernet ports.
Router	As far as networks of the type discussed in this manual are concerned, see Switch.
Secondary Ethernet Port	The Secondary Ethernet port can be used either as a daisy-chain output, repeating the network connection at the Primary port, or for the connection of a separate second network for full redundancy.
Short Circuit Protection	A Lab.gruppen proprietary protective circuit designed to mute a channel when a short circuit is detected at its output terminals to prevent damage to the device.
SpeakerSafe	Once activated, SpeakerSafe constantly monitors the voltage and current at the PLM's outputs. Using Fingerprint data, the software then calculates parameters such as voice coil and magnet temperatures, providing the operator with real-time performance monitoring. See LoadLibrary.
speakON	An industrial-quality loudspeaker connector manufactured by Neutrik. 4-pole (2 speakers) and 8-pole (4 speakers) versions are fitted to various versions of the PLM.
Star Topology	A network topology which uses a network switch to connect to individual Lake devices. Each device connects to one port on the switch with its own cable, thus the network looks like a star when drawn as a diagram with the switch at the centre.
Straight Network Cable	A Cat-5/6 network cable with full pin-to-pin connections is called a straight network cable. Lake devices can connect to a network using either straight or crossed network cables.
Subsystem	It is possible when working with large networked systems to store selected components of the system into a Subsystem. This is useful if working on a tour that encompasses both large and mid-sized venues. The same core Lake Controller data can then be used for a reduced number of Lake devices.
Super Module	A Super Module is a virtual construct that can be realized within the Lake Controller, allowing a set of Modules in different Frames to be treated as a single Module.
Switch (Ethernet)	An Ethernet switch allows several Ethernet devices to be connected to a network using a star topology. More intelligent than the earlier hubs which they now largely replace, they route packets of data only to the units for which they are intended, and also perform other system housekeeping and control functions.
System Preset	A class of Preset within the Lake Processing system, System Presets allow Module or Frame configurations and settings to be stored for the entire network of LM 26 Processors, PLM Series and other legacy Lake devices.
Tablet PC	A compact PC which uses a touchscreen instead of keyboard and mouse. The Lake Controller has been optimized for use on Tablet PCs.
Termination	AES3 digital audio interconnections must be correctly terminated for reliable operation. The 110 ohm terminations must be set 'on' at the beginning and end of a set of daisy-chained digital audio equipment, and 'off' at any intermediate ones.
Topology	A mathematical word for "arrangement" or "configuration". The topology of a network is a means of visualizing the overall configuration of the network.
Universal Power Supply	A power supply that operates in all countries, without the need for manual adjustment, as long as the voltage falls within the specified range for the device.
VHF Protection	VHF protection is another amplifier safety circuit developed by Lab.gruppen. The presence of continuous HF audio can easily damage loudspeakers, so the protection circuit monitors the output this, muting the power output channel if necessary
V peak	Indicates the peak voltage of an audio signal. For a sinusoidal signal, the peak voltage = 1.414 x the RMS voltage, Vrms. Not to be confused with peak-to-peak voltage (written V pk-pk), which = V peak x 2.
Vrms	The RMS voltage of a signal. See RMS.
Wireless Access Point	A device used to connect a computer to an Ethernet network without cables; a radio transmitter/receiver for data.
Wireless Network	An Ethernet network where some or all cabled connections are replaced by wireless links.

Table 9-5: Glossary of Terms, Acronyms and Abbreviations

10. Application Guide

This chapter describes the practical application and use of PLM Series devices.

10.1 Rack I/O Panels

For fast and simple system connection, pre-wired racks using connection panels can be used. With an I/O connector panel fitted to the front of the rack, all audio, loudspeaker, network and power cables can be plugged in at one position, without requiring rear panel access.

Although rental companies and large system users may have existing preferred designs, Figure 10-1 provides a suggested layout. This example provides AES3 and analog audio connections; a separate panel would be used for Ethernet connections.

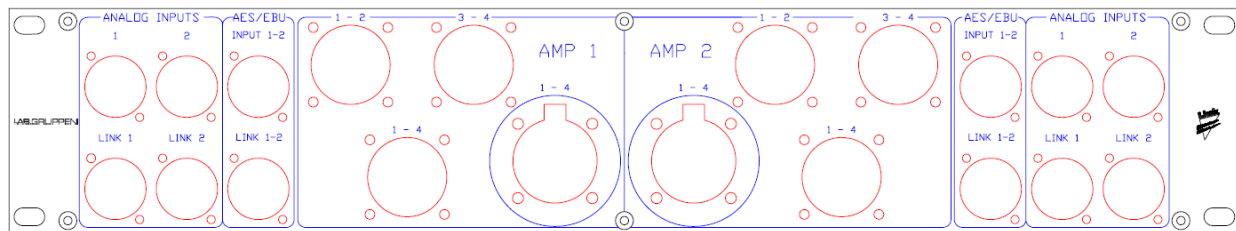

Figure 10-1: Example I/O Connector Panel

10.2 Power Distribution

For professional applications it is recommended that the sum of the available mains power is above 3000 W per PLM (e.g. 230 V x 16 A, 120 V x 32 A). As PLM 20000Q devices are equipped with BEL, the current draw of the device can be configured to perfectly match the power distribution. PLM 10000Q and PLM 14000 are equipped with PAL, so the power supply will limit its mains current draw (both momentary current draw and current draw over time) to be less than 28 A for the 230 V version and less than 53 A for the 115 V version.

Safety approved equipment is not required to have a mains breaker, as long as this does not pose any fire hazard under fault conditions, as is the case with the PLM.

Please see the following examples suggesting power distribution methods across multiple PLM devices. All of the examples given will work, although the first examples for both 230 V and 115 V operation have a slight advantage due to their “power sharing” ability.

10.2.1 Six PLM Series Devices with 230-240 V Mains Supply

If the mains supply is 230 V and the system requirement is six PLMs, then the mains capacity would need to be able to provide 3 x 32 A. There are two methods of achieving this:

1. Three racks, each with two PLMs and a 32 A single-phase mains supply. The 32 A capacity is shared between the two PLMs within the rack. This is beneficial as the two PLMs don't have to draw the same current. The only limitation is that in combination they don't draw over 32 A.
2. Three racks, each with two PLMs and a 16 A three-phase mains supply. This requires central power distribution to be configured as two 3 x 16 A circuits from 3 x 32 A. One phase is used for each PLM within the rack. This has the benefit that each PLM has its own breaker, but they all have to operate within the same limit of 16 A; therefore, more care must be taken to ensure that no breaker blows if different loads are used.



The 230 V version of the PLM is equipped with a slow-blow 30 A ceramic breaker.

10.2.2 Six PLM Series Devices with 100-120 V Mains Supply

If the mains supply is 115 V and the system requirement is 6 PLMs, then the mains capacity would need to be able to supply two 3 x 30 A circuits. There are two methods of achieving this:

1. Two racks, each with three 230 V version PLMs and a 30 A three-phase mains supply. In the rack the PLMs are connected between the phases, i.e. one between phase 1 and 2, one between phase 2 and 3 and the last between phase 3 and 1. Each 30 A mains breaker is shared between two PLMs and the mains current is to some extent canceled. This has the benefit that the three PLMs don't have to draw the same current; one can be allowed to draw a little more than the other two. The only limitation is that in combination they don't draw over 30 A.
2. Two racks, each with three 115 V version PLMs and a 30 A three-phase mains supply. One phase is used for each PLM within the rack. This has the benefit that each PLM has its own breaker, but they all have to operate within the same limit of 30 A; therefore, more care must be taken to ensure that no breaker blows if different loads are used.

10.3 Gain Structure

The PLM Series architecture provides gain adjustments at various points in the signal path and therefore, various places for muting and level adjustment. Each mute or gain adjustment point serves a different purpose. The signal flow diagrams in chapter 6 provide a useful reference for the signal path. The following sections describe the various adjustment points, all of which are available via the Lake Controller software.

10.3.1 Input Headroom (Analog Inputs Only)

Input Headroom should be set to 12 dBu if the source can be limited to 12 dBu; otherwise it should be set to 26 dBu. This setting does not affect the other gain stages, or the overall noise floor; it allows control of the appropriate headroom at the input stage only.

To adjust, navigate to I/O CONFIG > INPUT CONFIGURATION in the Lake Controller. Please refer to the Lake Controller Operation Manual for further details.

10.3.2 Input Mixer

Input Mixer gains can remain at 0.00 dB for most configurations; if only one input channel is used per Module, the other can be set to -INF.

To adjust, navigate to I/O CONFIG and tap the Input Mixer blocks for the Module in the Lake Controller. Please refer to the Lake Controller Operation Manual for further details.

10.3.3 Module Input Gain

Input Gain is used to adjust the level between different speaker cabinets in the system. This gain can remain at 0.00 dB unless a lower level is required for the cabinet/s driven by this Module.

To adjust, navigate to MODULES > EQ/LEVELS > LEVELS in the Lake Controller. Please refer to the Lake Controller Operation Manual for further details.

10.3.4 Module Output Gain (Levels)

Factory and User Gain are provided for each Module output. These two stages provide a level of security and control for the system designer (Factory) and a further level of adjustment for the user (User), both of which combine to balance the level between frequency bands in a multi-way crossover.

1. Factory Gain is set by the system designer and can be hidden within the Module file. The Factory Gain parameter is only accessible when the Module is unlocked and the Lake Controller is in Designer Mode. Adjust via MODULES > LEVELS > METER OPTIONS > ADJUST FACTORY.
2. User Gain is editable by a user unless the system designer has locked away the parameter; adjust via MODULES > LEVELS.

Generally, output gain values are configured within a Module / loudspeaker preset file and should not need to be adjusted further.

10.3.5 Attenuator

An attenuator gain adjustment is provided for each power output channel in the PLM. This control replaces the traditional volume control found on conventional amplifiers and should typically be left at 0 dB during use.

To adjust, navigate to I/O CONFIG > EVENTS & CONTROL > STATUS in the Lake Controller. Please refer to the Lake Controller Operation Manual for further details.

10.3.6 Amp Gain

The Amp Gain corresponds to the gain adjustment in a conventional separate loudspeaker processor and amplifier system. When using a pre-defined Module loudspeaker preset file, the Amp Gain settings will normally remain as defined in the file. The limiter and output gain settings of the Module were configured with this gain setting and will not be automatically compensated if changes are made. This configuration scheme, though unusual, allows for compatibility with legacy Dolby / Lake products.

When creating a loudspeaker preset Module file, adjust by navigating to I/O CONFIG > EVENTS & CONTROL > CONTROL in the Lake Controller. Please refer to the Lake Controller Operation Manual for further details.

10.4 Gain / Level Optimization

10.4.1 Maximize Volume Capability

To maximize the volume capability of the device, ensure there is sufficient headroom in the signal path to avoid clipping before the limiters engage. It must be possible to achieve enough gain through the device to engage the limiters and realize a high average SPL. As an optimal setting, allow for a headroom of 10 dB or more for all channels; the simplest way to accomplish this is to increase the Module input gain.

10.4.2 Minimize Noise

To help provide the best volume to noise ratio, use an AES or Dante digital input signal wherever possible. If using analog inputs, ensure that unused or unnecessarily high headroom is not introduced at the input to the device. If full or high average power is not required, the Module input gain may be reduced.

10.4.3 Gain Optimization Examples

This section provides examples on performance effects resulting from changes to the PLM gain structure.

10.4.3.1 Digital Input Gain Structure Examples

Figure 10-2 illustrates the recommended configuration of the PLM when using an AES or Dante digital input.

- ▶ Input Clip: 0 dBFS
- ▶ Amp Gain: 35 dB
- ▶ SNR: 114.2 dB
- ▶ Absolute Noise Floor: -71.3 dBu

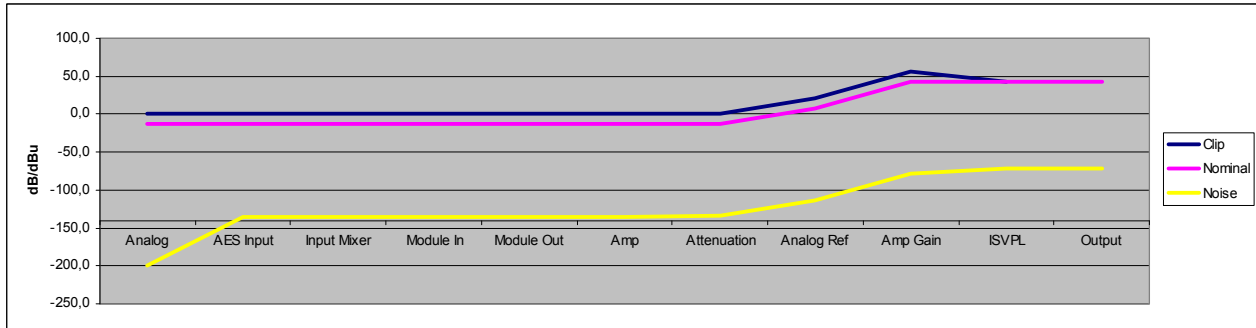

Figure 10-2: Digital Input: Low Noise with Good Headroom (High Input / High SPL)

Figure 10-3 illustrates how to achieve the lowest possible output noise, although this is not a recommended configuration.

- ▶ Input Clip: 0 dBFS
- ▶ Amp Gain: 22 dB
- ▶ SNR: 114.8 dB
- ▶ Absolute Noise Floor: -71.9 dBu

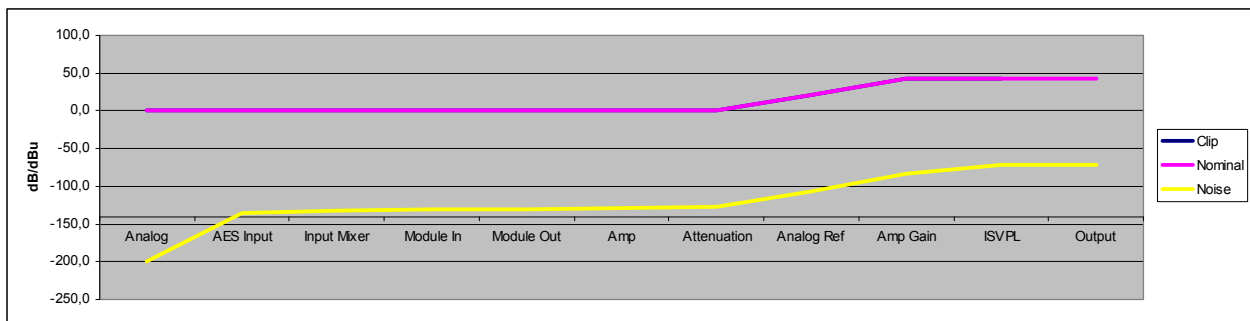

Figure 10-3: Digital Input Optimized for Minimum Noise - Not Recommended

The improvement in noise performance (at the cost of losing headroom and compression features) is only 0.6 dB; it is therefore not recommended to optimize performance in this manner.

10.4.3.2 Analog Input Gain Structure Examples

Figure 10-4 illustrates how to minimize absolute noise while limiting the available SPL.

Input Clip: 12 dBu

- ▶ Amp Gain: 22 dB
- ▶ SNR: 105.5 dB
- ▶ Absolute Noise Floor: -71.5 dBu
- ▶ SPL is limited to -8.9 dB relative to clip in this minimum absolute noise level example

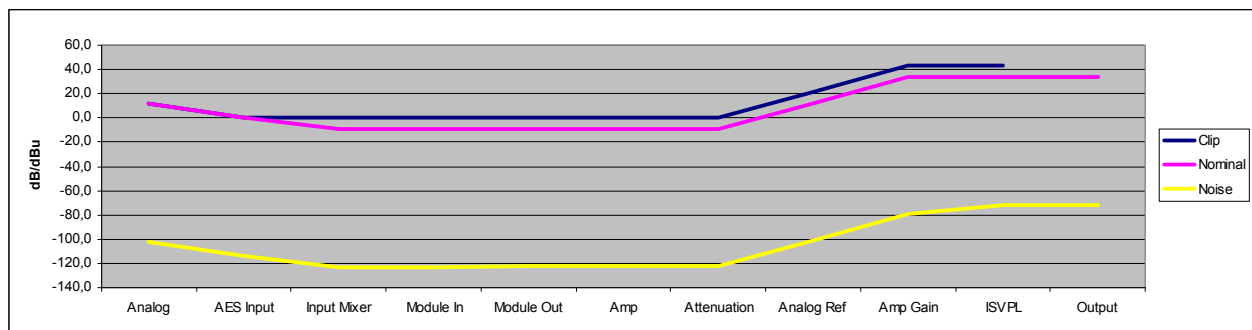

Figure 10-4: Analog: Low Noise with Limited Output (Low Input / Low SPL)

Figure 10-5 illustrates how to minimize absolute noise while achieving full power. In this illustration it can be seen that there is no available headroom.

- ▶ Input Clip: 12 dBu
- ▶ Amp Gain: 30.9 dB
- ▶ SNR: 111.3 dB
- ▶ Absolute Noise Floor: -68.4 dBu

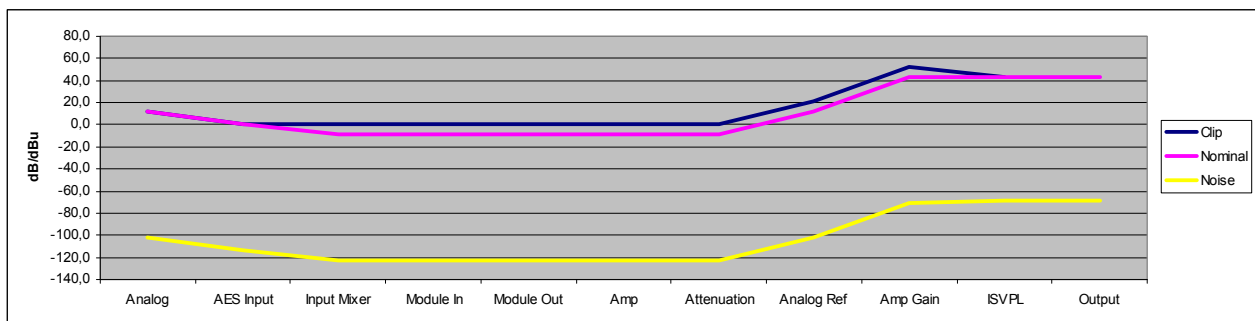

Figure 10-5: Analog: Low Noise with Full Output Power (Low Input / High SPL)

Figure 10-6 illustrates how moderate noise with extreme SPL can be achieved. SPL is extremely high in this example as maximum headroom is available at the input and within the processing stage. This makes it possible to increase the average SPL by utilizing internal compression capabilities.

- ▶ Input Clip: 0 dBFS
- ▶ Amp Gain: 35 dB
- ▶ SNR: 114.2 dB
- ▶ Absolute Noise Floor: -71.3 dBu

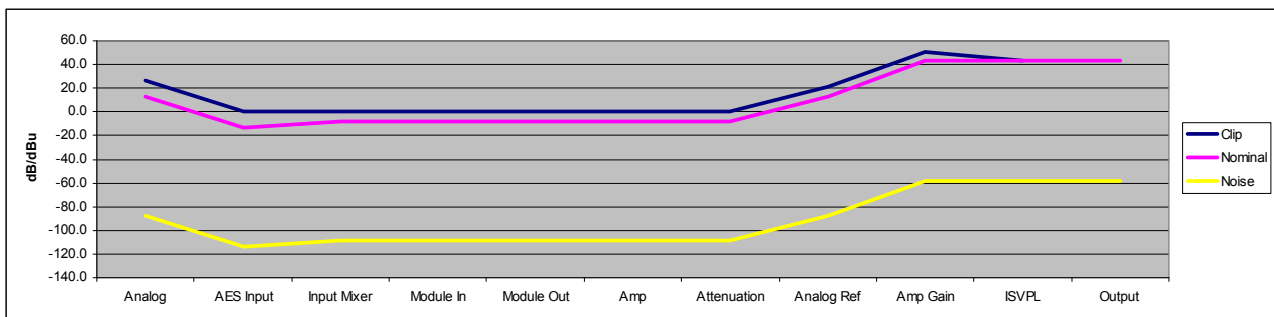

Figure 10-6: Analog Input: Moderate Noise with Very High Output (Very High SPL)

10.5 Speaker Configurations

Connecting two speakers in parallel to a PLM power output presents a load to the amplifier which is half the impedance of that presented by one speaker. Therefore, the current that two speakers will attempt to draw from the output stage is double that for one speaker, and this higher current may be sufficient to cause the Current Peak Limiter to become active. The more speakers connected to an output in parallel, the lower the impedance and the higher the current draw.

Multiple loudspeakers may be driven by a PLM power output more satisfactorily if a series-parallel wiring configuration is adopted. Please ensure care is taken to match polarity correctly.

When using series-parallel wiring, the nominal impedance is the same as with one speaker; however, the principle of power sharing still applies, and it is not possible to get the amplifier section to deliver more than its rated power.



Nominal loads as low as 2 ohms are supported by the PLM. However, a 2 ohm nominal load has impedance dips at its resonances below 2 ohms; in such cases it is likely that the resulting higher current will cause CPL to activate.

10.6 Digital Audio Connections

Whenever possible, it is preferable to connect a digital rather than analog input signal to the device. This is particularly relevant if the source signal is already in the digital domain, such as the source from a digital mixing console or digital distribution system. The primary cause of signal distortion and signal delay (latency) is the digital-to-analog and analog-to-digital conversion process. Therefore, using digital inputs normally provides higher quality audio with lower latency.

Two types of digital audio inputs are available: Dante networked multi-channel digital audio, and 2-channel digital audio via the AES3. Dante-based system configurations and interconnections are explained in a separate document, the Lake Network Configuration Guide.

The information in this section is supplied for users unfamiliar with AES3. Users already familiar with AES3 will find that the device conforms to established conventions.

10.6.1 AES3 Digital Audio

The original AES/EBU digital audio interface standard was developed by the Audio Engineering Society in conjunction with the European Broadcast Union. Originally published in 1985, it was revised in 1992 and 2003, and in its current iteration it is properly designated the AES3 standard.

AES3 is a serial transmission format for linearly represented (uncompressed) digital audio data. It describes a method for carrying two channels of periodically sampled and uniformly quantized audio signals on a single twisted-pair cable.

The data format allows for auxiliary data which can be used for information on signal characteristics as well as the sampled audio data. The physical interconnection, as defined by IEC 60958 Type I, specifies three-conductor 110-ohm twisted pair cabling terminated by an XLR connector. Please refer to section 8.3 for wiring details.

AES3 provides for multiple sampling rates and resolutions of up to 24 bits; this device accepts sample rates from 44.1 to 192 kHz.

10.6.2 System Latency and Delay Compensation

All types of digital audio processing inherently involves a small processing delay referred to as latency. If the processing chain does not involve analog-to-digital or digital-to-analog conversion, the amount of latency is usually very small and often may be disregarded.

However, in complex systems involving multiple digital audio components and connections, enough delay may be generated to cause audio phasing problems. Therefore, the lowest latency is always preferred, and it is always important to consider system latency delays when calculating and adjusting overall delay for time-aligning multiple loudspeaker systems.

10.6.3 Connections and Cabling

10.6.3.1 Input and Link Connectors

An AES3 input signal is connected to the XLR3F connector labelled INPUT 1-2 in the AES3 input section on the rear panel. An XLR3M connector, labelled LINK 1-2 is provided as a loop-through output for daisy-chaining multiple PLM Series devices.

The Input and Link connectors are identical for the analog and digital inputs, so care must be taken when connecting audio, particularly when analog inputs are used as a backup signal source. Connectors should be clearly labeled to prevent any confusion.



Never connect a digital signal source to an analog input or an analog signal source to a digital input.

10.6.3.2 Interconnection Options

If multiple PLM Series devices are receiving the same AES3 signal, connections may be configured in two ways:

1. Daisy-Chain – Connect the signal source (e.g. mixing console, digital snake or distribution amplifier) to the AES3 input on the first PLM. Connect the adjacent Link output on the same unit to the Input on the next PLM, and continue connecting in this manner. Up to 20 PLM units may be daisy-chained in this manner, though the total may be dependent on environmental conditions and the quality of connecting cables.
2. AES3 Distribution Amplifier – Connect the input of the distribution amplifier to the signal source, and connect the outputs individually to the PLMs. The number of available outputs must be equal to or greater than the number of PLM devices to be driven. The distribution amplifier must be specifically designed for AES3 signals; a device made for analog signals will not function in this capacity. Please refer to section 10.6.4 for further information.

Consider the application requirements carefully before choosing an interconnection configuration. Note that the daisy-chain option presents a potential single-point-of-failure scenario; failure of one cable or connection will affect all subsequent devices in the chain. Use of distribution amplifiers avoids this scenario, although extra expense is involved and potential failure of the distribution amplifier itself is introduced.

10.6.3.3 Cable Types and Distance Limitations

All digital connections should be made with 100 ohm balanced cables wired according to the AES3 standard (see Figure 8-11 on page 68). Although standard analog microphone cabling may function in limited circumstances, the potential for problems is greatly increased. AES3 contains a high-speed data stream, and requires an effective bandwidth of up to 12 MHz, far beyond the 20 kHz required for analog audio.

The distance allowed between a signal source and the PLM is dependent on both cable quality and the sampling rate used. At a 96 kHz sampling rate, any good quality AES3 cable should allow a cable run of 100 meters with no data losses beyond the capability of internal error correction. The best cables may allow longer cable runs, though careful trials are recommended before use in the field. Sampling rate also governs allowed cable length; a 100 meter length at 96 kHz might extend to 200 meters at 48 kHz, but be cut to 50 meters at 192 kHz.

10.6.3.4 Signal Degradation and Loss

A weak or degraded AES3 signal will exhibit no audible loss of quality as long as the robustness of the data stream remains above the threshold required for internal error correction. As degradation approaches the threshold, audible artifacts may be heard, including pops, clicks and momentary dropouts. Any such indications require immediate attention, as often the window of acceptable data loss between artifacts and complete audio loss can be very narrow.

As a precautionary measure for touring applications, it is advisable to configure all digital audio wiring prior to use. It is recommended that all cables be tested for error-free performance at lengths 20% to 25% greater than lengths to be used in the field in order to provide a comfortable margin of safety.

10.6.4 External Signal Distribution Hardware

10.6.4.1 Distribution Amplifiers

Dedicated distribution amplifiers for AES3 signals are available from several manufacturers. The most common format is one input and six outputs. Digital distribution amplifiers are designed to refresh or reconstruct the signal as well making up for line losses.

One type of distribution amplifier is a simple repeater, which restores the waveform shape and brings the signal amplitude back up to the required level. Some distribution amplifiers also offer a re-clocking feature, which also re-times the signal to prevent signal degradation from clocking errors known as jitter.

Distribution amplifiers that offer re-clocking often make the feature optional as using re-clocking can introduce small additional amounts of latency, so should not be used unless necessary.

10.6.4.2 Passive splitters

In some limited applications, a single AES3 input may be split into two signals using a simple passive splitter. Splitters provide a convenient and low cost solution when only one additional signal is required, and in situations where cable lengths are short. Attenuation is minimal, but there is no refreshing of the signal.

10.6.5 Additional Reference Material

Complete technical information on the AES/EBU (AES3) standard can be downloaded from the AES web site at <http://www.aes.org/publications/standards/>.

10.7 Digital Clock Configuration

10.7.1 Digital Clock Overview

In order to provide a flexible and robust audio processing system, the PLM is equipped with a configurable digital clocking system. The digital clock can generate various independent internal sample rates, or can sync to an incoming AES3 signal. Figure 10-7 shows the various sample rates and options available.

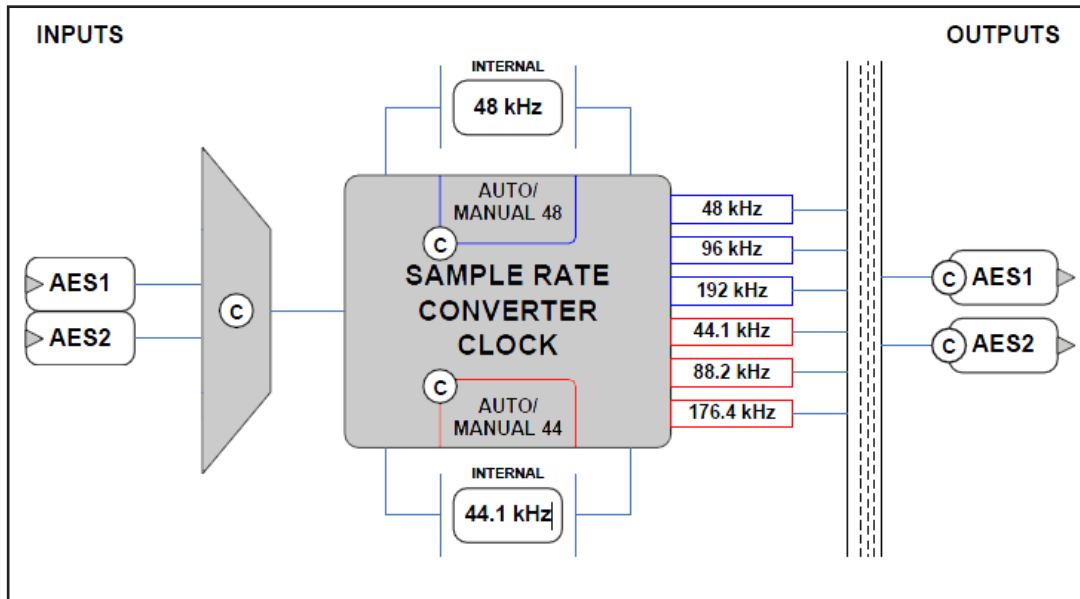

Figure 10-7: Digital Clocking System

In Figure 10-7, each circled C represents a choice point. A choice point is a user-interface control that can be configured using the Lake Controller software. Please refer to the Lake Controller Operation Manual for further information.



Figure 10-7 indicates internally generated clocks with base-rate multiples of 44.1 kHz or 48 kHz. This should not be confused with the internal DSP sample rate of 96 kHz.

The PLM digital clocking system can either generate its own internal clock, or synchronize to an incoming external clock source via the AES3 digital input.

10.7.2 Clock Source Priorities

There are two options for clock source configuration: Manual Configuration or Automatic Detection.

For Manual Configuration, the selected internal or external clock source remains fixed regardless of whether a compatible clock signal is preset.

For Automatic Detection, the most appropriate clock matching the selected base-rate is automatically selected according to the following priorities.

1. AES1 (Input 1+2)
2. Internal Clock

When using automatic detection, the AES3 digital input is monitored and will switch the clock source back and forth depending on the availability of an AES3 signal.

Please refer to the Lake Controller Operation Manual for additional information.

10.7.3 Dante Clock Configuration

Dante uses its own digital clocking technology across the Ethernet network to ensure that all Dante devices are synchronized. As part of this logic, an order of priority is defined to identify which device becomes the Dante Master. A Dante-capable device with a valid BNC Word Clock is chosen as the highest priority, followed by a device with a valid AES3 signal, then SPDIF, then an internally generated clock.

Dante only operates at 48 kHz or 96 kHz, with the PLM digital clock on all Dante Slaves being overridden by the Dante Clock.

The front panel Input View indicates if that device is selected as Dante Clock Master. Confirmation of Dante Master / Slave status is also displayed in the Lake Controller.



For further information on Digital Clock configuration and the Lake Controller user interface, please refer to the Lake Controller Operation Manual.

Table 10-1:

11. Technical Specifications

Model	PLM 20000Q	PLM 14000	PLM 10000Q
Number of input channels	2	2	2
Number of output channels	4	2	4
Peak total output all channels driven	20000 W	14000 W	10800 W
Max. Peak output voltage per channel	194 V	193 V	153 V
Max. output current per channel	67 A peak	90 A peak	49 A peak
Max. Output Power			
16 ohms per ch. (all ch.'s driven)	1150 W	1150 W	660 W
8 ohms per ch. (all ch.'s driven)	2300 W	2300 W	1300 W
4 ohms per ch. (all ch.'s driven) ¹⁾	4400 W	4300 W	2300 W
2 ohms per ch. (all ch.'s driven) ¹⁾	4800 W	7000 W	2350 W
All channels driven into optimal impedance interval	>5000 W into 2.2 - 3.3 ohms	>7000 W into 1.8 - 2.1 ohms	>2700 W into 2.4 - 3.2 ohms
8 ohms bridged per ch.	8800 W	8600 W	4600 W
4 ohms bridged per ch.	9600 W	14000 W	4700 W
Bridged into optimal impedance interval	>10000 W into 4.4 - 6.6 ohms	>14000 W into 3.6 - 4.2 ohm	>5400 W into 4.8 - 6.2 ohms
Audio Performance			
THD + N 20 Hz - 20 kHz for 1 W	<0.05%		
THD + N at 1 kHz and 1 dB below clipping	<0.04%		
Dynamic range with digital inputs (for all supported sample rates)	>114 dB	>114 dB	>116 dB
Dynamic range with analog inputs	>110 dB	>110 dB	>112 dB
Frequency response (1 W into 8 ohms, 20 Hz - 20 kHz)	+/-0.05 dB		
Common Mode Rejection (CMR)	>74 dB, 20 Hz to 20 kHz		
Internal sample rate	96 kHz		
Internal data path	32 bit floating point		
Product propagation delay, best case (96 kHz AES)	1.61 ms		
Product propagation delay, analog input	1.68 ms		
Sample Rate Converters			
THD + Noise	0.00003 %, 20 Hz - 20 kHz, unweighted		
Analog to Digital inputs			
Inputs	2 inputs x 2 link		
Input sensitivity settings	+12 or +26 dBu		
THD + Noise	0.00022 %, typical at 1 kHz unweighted at +26 dBu headroom setting		
	0.00033 %, typical at 20 Hz and 20 kHz unweighted at +26 dBu headroom setting		
AES / EBU inputs			
Inputs	2 inputs x 2 link		
Supported resolutions	≤ 24 bit		
Supported sample rates	44.1, 48, 88.2, 96, 176.4, 192 kHz		
Dante Audio Network			
Inputs and outputs	2 inputs, 2 outputs		
Supported sample rates	48, 96 kHz		
Supports redundant paths	Yes		
Flexible topology	Yes		
Network latency	0.8, 1.3 and 4 ms		
Device presets			
Local memory locations for the settings of the product	100		
Limiters			
Adjustable Inter-Sample Voltage Peak Limiter (ISVPL)	17.8 - 194 V, step size 0.1 V	17.8 - 193 V, step size 0.1 V	17.8 - 153 V, step size 0.1 V
Current Peak Limiter < 300 ms	67 A peak	90 A peak	49 A peak
Current Average Limiter (CAL) > 300 ms	33 Arms	44 Arms	25 Arms
LimitersMax (rms and peak limiters)			
- MaxRMS (rms voltage limiter)	Yes		
- MaxPeak (peak voltage limiter)	Yes		
Gain			
Amplifier gain	22 - 44 dB, step size 0.1 dB		
Output attenuator	-Inf to 0 dB, step size 0.25 dB		
Rear-panel interface			
AES / EBU / I/O (input + link)	2 x 3-pin XLR		
Analog, 2-channel I/O (input + link)	4 x 3-pin XLR, electronically balanced		
Output connectors	Neutrik speakON (1 x NLT8, 2 x NLT4) or 4 Binding Posts (pairs)	Neutrik speakON (2 x NLT4) or 4 Binding Posts (pairs)	Neutrik speakON (1 x NLT8, 2 x NLT4) or 4 Binding Posts (pairs)
Auto 10/100, Auto Uplink	2 x RJ45 etherCON		
Control and monitoring interface	Via Ethernet for Lake Controller software, or DLM (the 3rd Party Protocol)		
Detachable mains cord	Neutrik powerCON 32 A		
Cooling	Three fans front-to-rear airflow, temperature controlled speed	Two fans front-to-rear airflow, temperature controlled speed	Two fans front-to-rear airflow, temperature controlled speed
Front-panel user interface			
Display	2.5 inch, daylight readable LCD		
Fault/Warning/Limit/Clip indicators	RGB LEDs and detailed fault description on display		
Mute and soft function buttons	8 provided		
Standby Power button	On/Standby		
Mute Enable button	Enables muting of outputs and inputs via soft-button keypad		
Meter button	Toggles through meter views		
Menu button	Provides a menu driven interface for full function front panel control		
Rotary Encoder	Yes		
Exit button	Provides a "back" function		
Power			
Operating voltage (45 - 66 Hz)	Universal power supply 70 - 265 V	140-265 V / 70-135 V ²⁾	140-265 V / 70-135 V ²⁾
Soft start / Inrush Current Draw	Yes / max. 8 A	Yes / max. 5 A	Yes / max. 5 A
Power Average Limiter (PAL)	Yes	Yes	Yes
Power Factor Correction (PFC)	Yes	No	No
Breaker Emulation Limiter (BEL), software controlled 5 - 32 A	Yes, selectable breaker profile	No	No
Under-Voltage Limiter (UVL)	Yes	No	No
Dimensions			
Rack rail to rear panel	W: 483 mm (19"), H:88 mm (2 U), D: 424 mm (16.7")	W: 483 mm (19"), H: 88 mm (2 U), D: 386 mm (15.2")	W: 483 mm (19"), H:88 mm (2 U), D: 386 mm (15.2")
Overall depth including handles and rear support	498 mm (19.6")	460 mm (18.1")	460 mm (18.1")
Weight			
	17 kg (37 lbs.)	13.5 kg (30 lbs.)	13.5 kg (30 lbs.)
Finish			
	Black painted steel chassis with black painted steel / aluminum front		
Approvals			
	CE, ANSI/UL 60065 (ETL), CSA C22.2 NO. 60065, FCC		

Note 1): Asymmetrical loading of the outputs will yield even higher ratings. If one (or two) channel(s) has reduced power requirements, then the voltage drop from the power supply will be reduced, resulting in higher power availability for the other channel(s).

Note 2): Separate 230 V or 115 V versions available. Not selectable on the product.

All specifications are subject to change without notice.

12. Warranty and Support

12.1 General

This product is manufactured by Lab.gruppen, and it is warranted to be free from any defects caused by components or factory workmanship, under normal use and service, for a period of three (3) years from date of purchase from an authorized Lake dealer.

If the product fails to perform as specified during the warranty period, Lab.gruppen will undertake to repair, or at its option, replace this product at no charge to its owner, provided the unit is returned undamaged, shipping prepaid, to an authorized service facility or to the factory.

This warranty shall be null and void if the product is subjected to: repair work or alteration by a person other than those authorized by us; mechanical damage including shipping accidents; war, civil insurrection, misuse, abuse, operation with incorrect AC voltage; incorrect connections or accessories; operation with faulty associated equipment; or exposure to inclement weather conditions. Damage due to normal wear and tear is not covered by the warranty. Units on which the serial number has been removed or defaced will not be eligible for warranty service.

Lab.gruppen shall not be responsible for any incidental or consequential damages. Lab.gruppen's responsibility is limited to the product itself. Lab.gruppen takes no responsibility for any loss due to cancellation of any events, or rent of replacement equipment or costs due to a third party's or customer's loss of profit, or any other indirect cost or losses however incurred.

Lab.gruppen reserves the right to make changes or improvements in design or manufacturing without assuming any obligation to change or improve products previously manufactured.

This warranty is exclusive, and no other warranty is expressed or implied. This warranty does not affect the customer's statutory rights.

12.2 International Warranties

Please contact your supplier or distributor for this information, as rights and disclaimers may vary from country to country.

12.3 Technical Assistance and Service

12.3.1 International Service

If your Lab.gruppen product requires repair, contact your Lab.gruppen dealer or distributor, or contact Lab.gruppen by fax or email to obtain the location of the nearest authorized service centre.

12.3.2 Factory Service

In the event a Lab.gruppen product requires factory service, you may contact Lab.gruppen's service department for return instructions and a Return Authorization number.

Please note for product return:

1. Use the original packing.
2. Include a copy of the sales receipt, your name, return address, phone and fax number, email address and description of the defect.
3. Mark the Return Authorization number on the outside of the packing.
4. Ship the product prepaid to:

Lab.gruppen
Faktorvägen 1
SE-434 37 Kungsbacka
SWEDEN

Phone: +46 300 56 28 00

Fax: +46 300 56 28 99

service@labgruppen.com

www.labgruppen.com

12.4 Trademarks

Intercooler, Class TD and Lake are national and/or international registered trademarks of Lab.gruppen AB. PLM, Powered Loudspeaker Management, LM 26, R.SMPS, LoadLibrary, LoadSmart, SpeakerSafe, ISVPL, BEL, UVL and CAL are trademarks of Lab.gruppen AB.

Dolby is a registered trademark of Dolby Laboratories. Raised Cosine Equalization, LimiterMax and Iso-Float are trademarks of Dolby Laboratories. Audinate is a registered trademark of Audinate Pty Ltd. Dante and Zen are trademarks of Audinate Pty Ltd.

All other trademarks remain the property of their respective owners.

Copyright © 2010 Lab.gruppen AB. All rights reserved.



LAB.GRUPPEN

LAB.GRUPPEN AB ▶ SWEDEN
INTERNATIONAL CONTACT ▶ INFO@LABGRUPPEN.COM
US & CANADA CONTACT ▶ INFO@TCG-AMERICAS.COM
WWW.LABGRUPPEN.COM